



TOP HAMMER DRILLING TOOLS

Percussive Products



TABLE OF CONTENTS

HARD ROCK TOOLING OVERVIEW	5	ACCESSORIES	99
History	6	Adapter Couplings	100
Bit Types	8	Male/ Female Bit Adapters	100
Bit Face Designs	10	Spiral Male / Female Bit Adapters	100
Button Types	11	Male / Female Adapter Guides	101
Blade Bit Designs	12	Split Set Drivers	101
Reaming Tooling Designs	13	Driver Nuts	102
Rod Types	14	Spear – Female End	102
Thread Types	15	Spear – Male End	102
Thread Compatibility	16	Bell Taps	103
Coupling Types	17	Knock Off Blocks	103
Shank Adapters/Striking Bars	18	Reaming Shell Adapters	103
RST™ Series	19	Bit Resharpening Gauge	104
Lightning Rod Series	20	H22 Chuck Gauge	104
HANDHELD DRILLING TOOLS	21	TROUBLESHOOTING	105
7° System	22	Collared and Tapered Rods	106
11° System	23	Blade Bits	108
12° System	25	Button Bits	109
Rod Shanks	27	Couplings	112
Collared Reamer Tools	28	Shank Adapter	113
NRT Extension Tools	29	Drill Steels	115
Integral Drilling Tools	29	CARE AND HANDLING	117
TUNNELING / DRIFTING /		Bit Wear Overview	118
LONGHOLE DRILLING TOOLS	31	Bit Wear Patterns	119
R23 System	32	Product Servicing	120
R25 System	33	Recommendations	121
R28 System	36	WARRANTY	123
R32 System	38	PRODUCT INDEX	127
R35 System	47	CONTACT INFORMATION	133
HM35 (T35) System	50		
R38 System	51		
HM38 (T38) System	53		
HM45 (T45) System	59		
HM51 (T51) System	66		
BE58 System	71		
EL60 System	73		
BE68 System	76		
EL68 System	78		
SHANK ADAPTERS	81		
Boart Longyear	82		
Atlas Copco	83		
Cannon	86		
Caterpillar / Gardner Denver	86		
Furukawa	89		
Ingersoll Rand	91		
Montabert	91		
PW	93		
Sandvik / Tam Rock	93		
SCM	97		
SVK	97		
Toyo	98		
UDR	98		

HARD ROCK TOOLING OVERVIEW	5
HANDHELD DRILLING	21
TUNNELING/DRIFTING/LONG HOLES DRILLING TOOLS	31
SHANK ADAPTERS	81
ACCESSORIES	99
TROUBLESHOOTING	105
CARE AND HANDLING	117
WARRANTY	123
PRODUCT INDEX	127
CONTACT INFORMATION	133



OVERVIEW

History	6
Bit Types	8
Bit Face Designs	10
Button Types	11
Blade Bit Designs	12
Reaming Tooling Designs	13
Rod Types	14
Thread Types	15
Thread Compatibility	16
Coupling Types	17
Shank Adapters/Striking Bars	18
RST™ Series	19
Lightning Rod Series	20

HISTORY

125 Years of Drilling Innovation

In 1888, a young graduate of the Michigan School of Mines, Edmund J. Longyear, revolutionized the mining industry on June 3, 1890, by introducing diamond drilling to the primitive pickaxe exploration of the Mesabi Iron Range in northern Minnesota. Forming a contract diamond drilling services company to serve the rapidly growing U.S. iron ore mining and steel industry, for the next twenty-one years, 1890-1911, Edmund sank thousands of drill holes along the one-hundred-mile Mesabi range.

The mining industry was booming, and new machines to simplify the labor intensive business were in demand. The Longyear name became well-known in mining circles, and before long, requests for diamond drilling equipment as well as drill contracting solidified Longyear's niche in the business. In 1912, the E.J. Longyear ("Longyear") Company released its first price list, which featured 19 drill models with drilling capabilities between 750 and 5,000 feet. Those drills were powered mainly by steam engines, which later would be replaced by internal combustion engines.

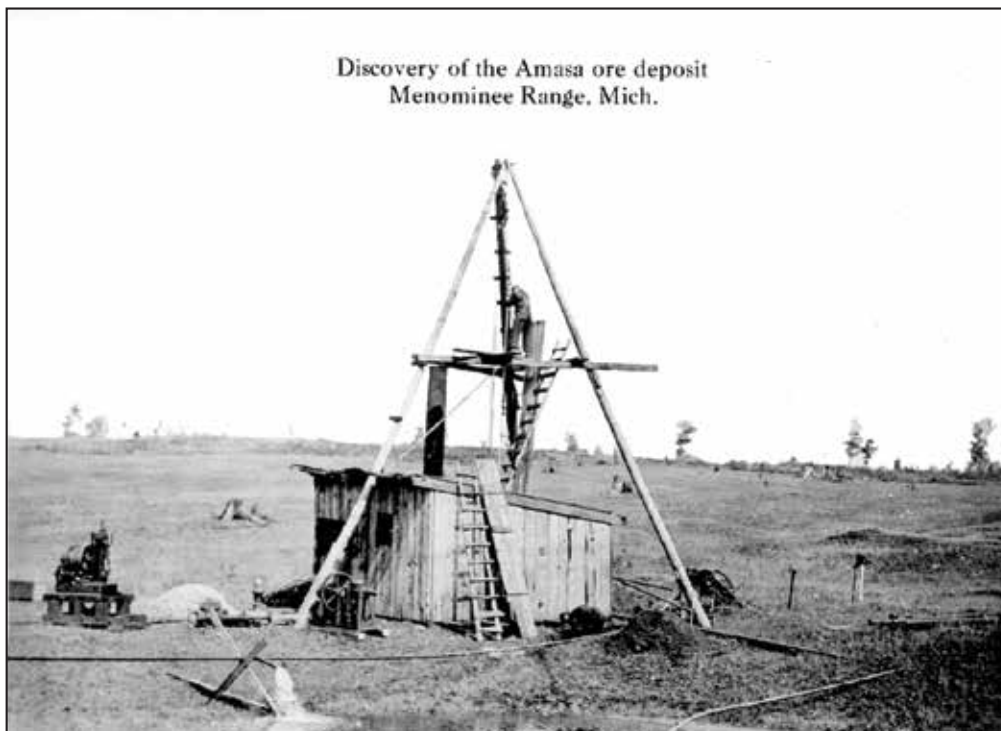

HISTORIC TIMELINE

1890

1890: Edmund J. Longyear signs his first contract for drilling services.

1930

1936: South Africa's Anglo American Corporation forms Boart Products South Africa (Pty) Limited.

1940

1950

1961: Longyear acquires Mississauga manufacturing plant.

1960

1970

1974: Longyear acquired by Anglo American in 1974.

Global expansion began in 1912 and by 1932, the company had operations in Canada, Cuba, China, and Africa.

Today, focused on the success of our customers, Boart Longyear utilizes innovation to drive productivity and safety on site. The Products division designs, manufactures, and sells drilling equipment, performance tooling, and aftermarket parts and services to customers in over 100 countries. Our range of highly productive drill rigs is suited for a variety of applications, including mineral exploration, mining, energy, environmental sampling and remediation, as well as infrastructure reinforcement and development.

Boart Longyear's Drilling Services division provides drilling services for surface drilling, underground drilling, and water management. We offer first-rate experienced crews, field-developed equipment and technologies and provide drilling services ranging from diamond core, to reverse circulation, to sonic drilling in over 30 countries. And on every job around the world, our commitment to safety is unsurpassed.

As the world's leading drilling products and services provider, we understand better than most how spare parts and service availability is critical to the success of a drilling operation. Consider us your partner in keeping your projects running with lower operating costs and higher returns on your equipment investments.

As an integrated drilling services and products provider, Boart Longyear combines engineering excellence, global manufacturing facilities, and the most experienced drilling services group in the business. The result is high quality, easy to use, and safe equipment and tooling that are the most trusted and reliable in the industry.

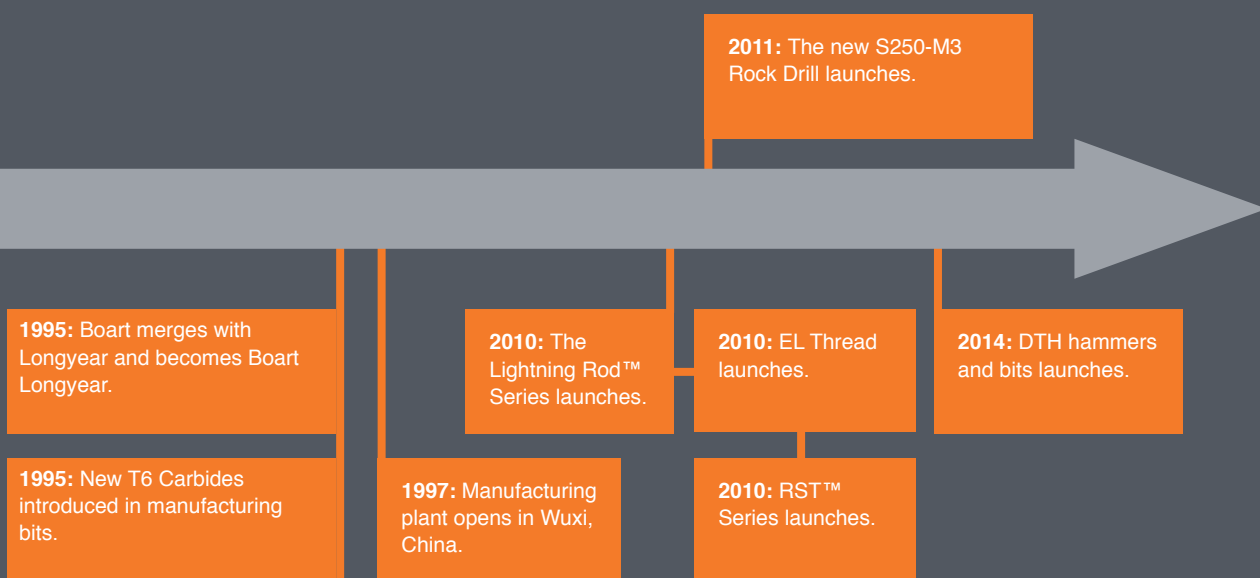

INTRODUCTION

This section provides general descriptions, guidelines, and recommendations for all of the components found in this catalog. Design descriptions and explanations are provided to assist you in selecting the correct tooling for the job.

BIT TYPES

Button Bit

- Fast penetration
- More adaptable to different types of ground conditions, due to the different configurations of designs and buttons available

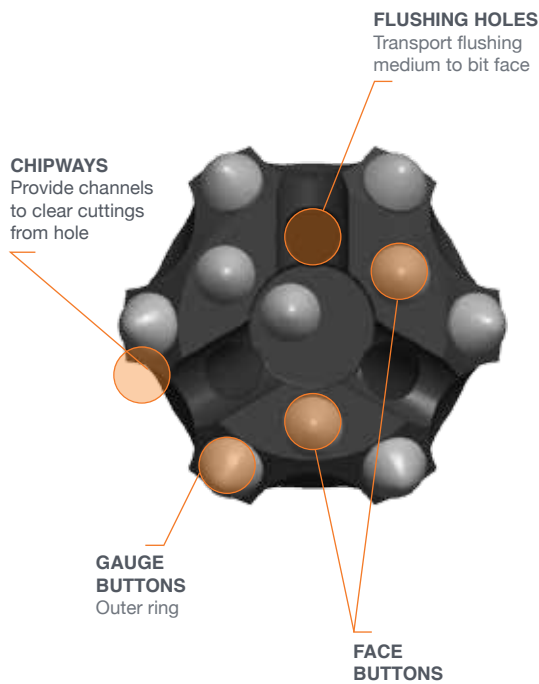

Blade Bit

- Maintains hole diameter with reduced gauge wear
- Reduces hole deviation
- Different types of carbides for different ground conditions

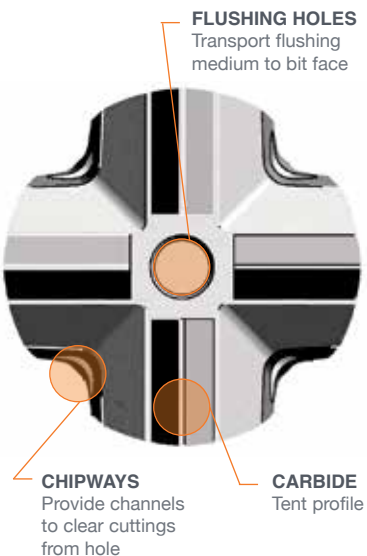

BIT TYPES

Button Bit Components

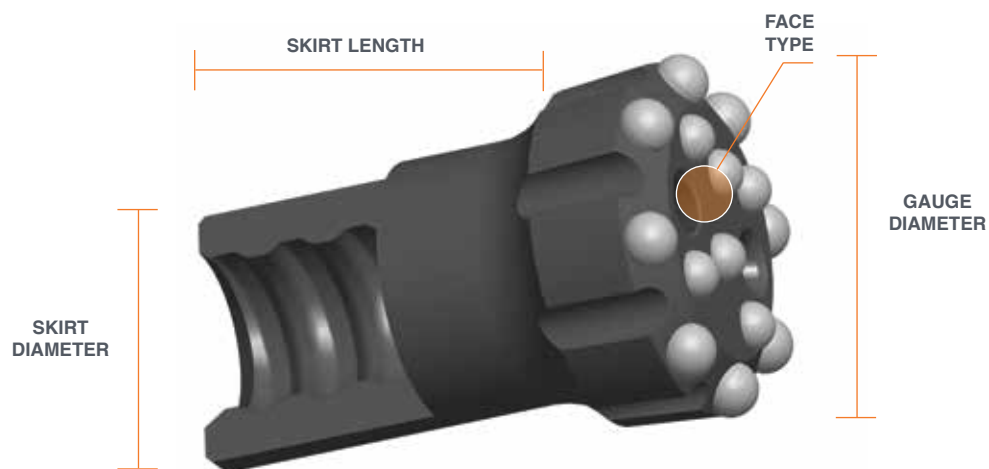

Special Skirt Designs

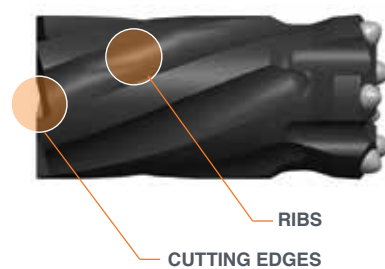
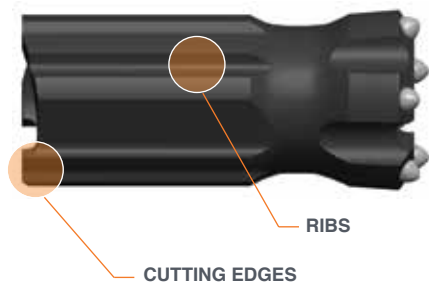

- Cutting edges in skirt for easy removal of bit in adverse hole conditions

Straightrac Bit

- Angled flute design for 360 degrees of contact, reducing the hole deviation
- Cutting edges in skirt

BIT FACE DESIGNS



BR - Button Recessed

“Drop Center” face characteristic

- Reduced hole deviation
- Broken ground conditions



BF - Button Flat

“Flat” face characteristic

- General purpose bit
- Hard to medium conditions



BC - Button Chisel

Chisel shape characteristic

- Abrasive conditions
- Fast penetration



BD - Button Dome

- Clearly defined raised face profiles
- Primary reaming applications in soft ground

BUTTON TYPES



Hemispherical Button

- Best suited for hard ground
- 25,000 to 45,000 PSI (170 to 300 MPa)
- Abrasive to very abrasive



Parabolic Button (Semi Ballistic)

- Fast penetration
- Best suited for medium ground
- 15,000 to 25,000 PSI (100 to 170 MPa)
- Mildly abrasive ground



Conical Button

- Application Strength – fast penetration
- Suited for all non-abrasive ground types
- Smaller contact area
- Best suited for smaller diameter bits



Ballistic Button

- Fast penetration
- Suited for all non-abrasive ground types
- Smaller contact area
- Best suited for smaller diameter bits

BLADE BIT DESIGNS

Blade bit designs are limited to cross and “X” type face configurations.

- 32 mm to 57 mm are restricted to a cross configuration.
- 57 mm or larger usually have an ‘X’ configuration.

In special circumstances, blade bits are preferred.

- Blade bits tend to resist gauge wear better than button bits.
- Hole accuracy is required and very hard, abrasive ground is encountered.



Cross Bits

- Easier to sharpen than X-bits, inset angles are equal on all four sides
- Bits 64 mm and less are easier to sharpen than button bits of the same size.
- In certain rock conditions, cross bits tend to produce a spiraled five sided hole (especially in diameters larger than 64 mm).



“X” Bits

- X-bits tend to drill round holes in all rock conditions.
- The steel support in the narrow parts of the X becomes inadequate in X-bits smaller than 64 mm because of the restricted circumference.

REAMING TOOLING DESIGNS

Reaming Bits or Hole Openers

Description

- Pilot holes are drilled to depth and then reamed out to a larger diameter in a second pass.
- Required when hole diameter exceeds the capabilities of the rockdrill and drilling tools available

Applications

- Large diameter service holes from level to level for drainage, electrical cable or pipe lines
- Reaming cut holes for development rounds and for long hole blasting of drop raises



Button Bit Reamer - One Piece Bit

- Has an integral pilot on the face of the reamer



Button Bit Reamer - One Piece Bit - Dome



Pilot Adapter/Reamer - Two Piece System

- The reaming assembly is made of a 6° tapered pilot adapter that threads on the lead steel with a taper socket reaming bit fitted on the pilot.

ROD TYPES



Round Rods

- Normally used in extension drilling applications
- Generally lighter than hexagonal rods of an equivalent size
- Available in large x-sectional diameters
- Diameter of rod is based on external dimension

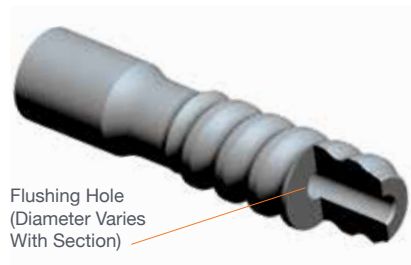

Hexagon Rods

- The cross sectional dimension of material is measured across the flat.
- Cross sections are more rigid, heavier & transfer energy more efficiently.
- Reduces the annulus in the drill hole for better flushing.
- Smaller space combined with the corners of the steel create turbulence in the hole, keeps the heavier cuttings moving, especially with horizontal holes.
- The rigidity of the cross section makes it possible to use a larger thread.

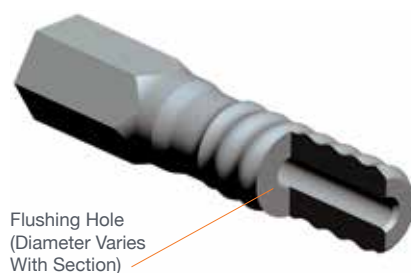

Carburization

- Entire rod is hardened providing a case over the entire rod surface both internal and external.
- Primarily used in underground applications and where water is used as a flushing medium

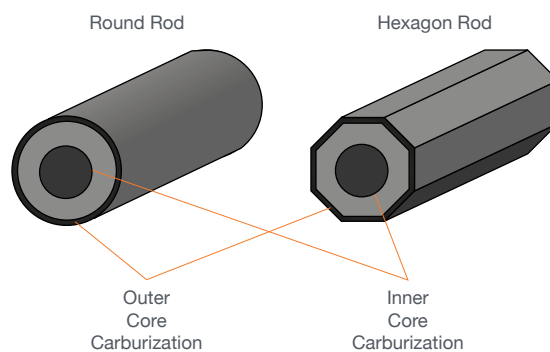

High Frequency (H/F) Induction

- Only the thread ends of the rod are hardened
- Primarily used in surface drilling applications where air is the primary flushing medium

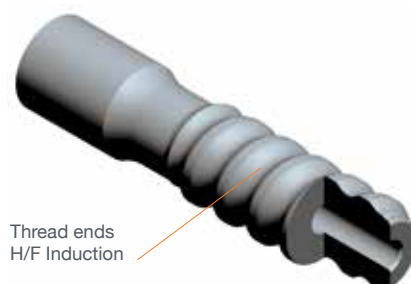

THREAD TYPES

R Thread (Rope)

- Rope threads — low pitch, 12.7 mm and a small angle of profile
- Sizes: 22 mm – 38 mm
- Good wear properties
- Ideal for single pass or shorthole drilling such as underground tunneling applications that require infrequent uncoupling



HM (T) Thread

- HM thread or “T” thread — larger pitch and a larger angle of profile than the Rope thread
- Sizes 38 mm, 45 mm and 51 mm
- Excellent wear properties and good coupling qualities
- Ideal for extension drilling with multiple steel
- Greater torque capacity



EL Thread

- Similar angle of profile to the HM thread
- Designed for a 60 mm and 70 mm diameter extension steel for use with the new generation high powered rockdrills
- Excellent wear resistance and a pitch angle that uncouples easily



BE Thread (Tube Rod)

- Thread is a shoulder drive system (available in bottom drive as well). The shoulders on the pin and box butt together to transmit the energy.
- Excellent wear properties and good coupling qualities
- Used in extension tube drilling with multiple tube steels.
- Compatible with high-torque top hammer rockdrills for surface and underground applications



THREAD COMPATIBILITY

This table shows thread compatibility between manufacturers to ensure proper threading between tooling.

THREAD TYPE	SIZE	BOART LONGYEAR	SANDVIK	ATLAS COPCO
R	22	✓	✓	✗
	23	✓	✓	✗
	25	✓	✓	✓
	28	✓	✓	✓
	32	✓	✓	✓
	35	✓	✓	✓
	38	✓	✓	✓
	HM/T*	35	✓	✓
38		✓	✓	✓
45		✓	✓	✓
51		✓	✓	✓
SPECIALTIES	SR28	✗	✗	✓
	SR32	✗	✗	✓
	SR35	✗	✗	✓
	a250	✗	✓	✗
	a330	✗	✓	✗
	BE58EXT/ SANDVIK 60**	✓	✓	✗
	GT60	✗	✓	✗
	T60	✗	✗	✓
	EL60	✓	✗	✗
	EL68	✓	✗	✗
TUBE DRILLING BE/ ST	58	✓	✓	✓
	68	✓	✓	✓

* T is used by Atlas Copco and Sandvik and HM is used by Boart Longyear, T and HM are fully compatible

** BE58EXT, used by Boart Longyear, and Sandvik 60 (ST58) are the bottom drive versions of the 58 system. BE58EXT and Sandvik 60 are fully compatible.

COUPLING TYPES

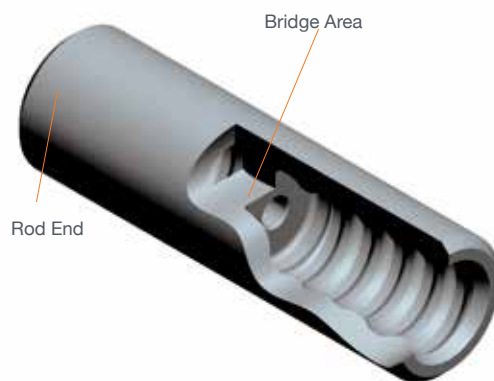
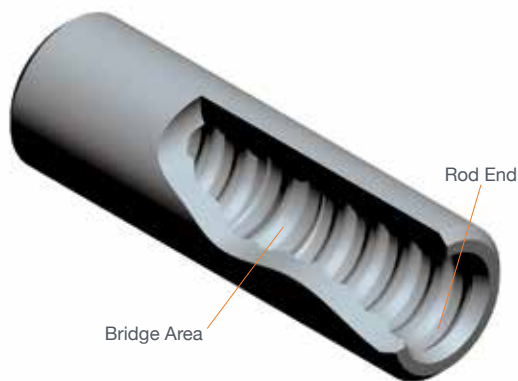

Semi-Bridge Coupling

- Small non-threaded bridge in the center
- Steel cannot thread past bridge area
- Smaller diameter steel end portions fit together in the center bridge area of the coupling
- Semi-bridged couplings are most suited to high-torque machines
- Most rope and HM threaded couplings are semi-bridged
- Best energy transfer

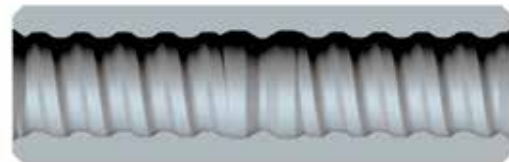

Full-Bridge Coupling

- Eliminates the potential for the coupling to creep along the threaded joints
- Typically used in surface applications
- Better uncoupling characteristics and tends to maintain tighter joints
- Less chance of jamming
- Best suited to machines equipped with independent rotation (ie., S36IR rockdrill)

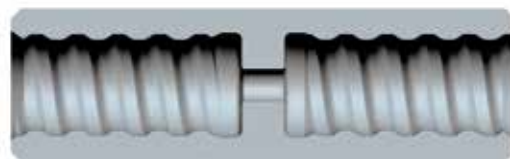

Adapter Coupling

- Use when changing from one thread type or size to another and are typically required only in special circumstances

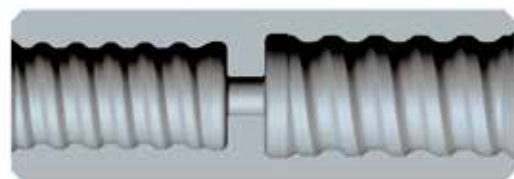

SHANK ADAPTERS/STRIKING BARS

Hydraulic and Pneumatic Shanks

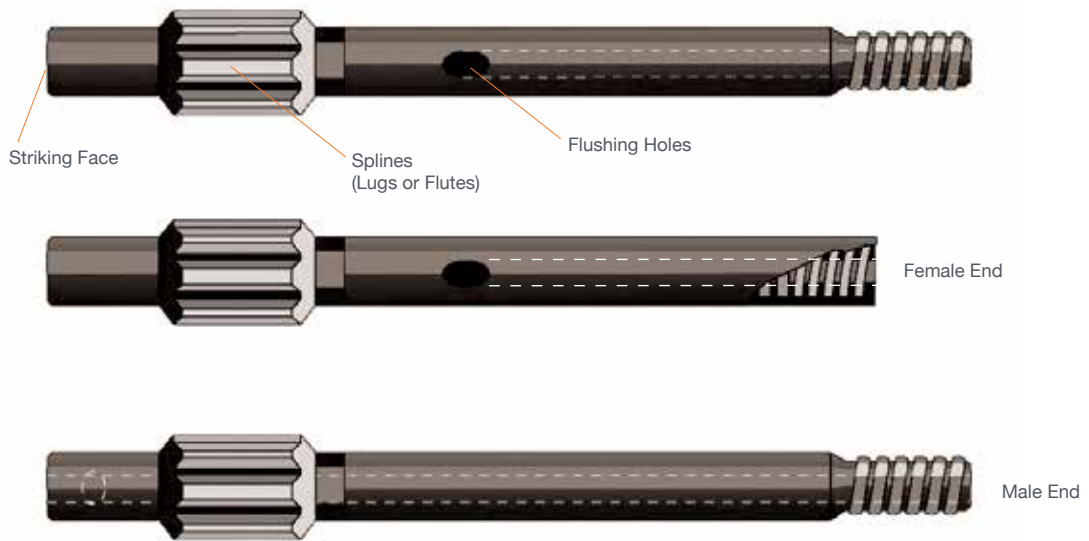

- Male shank adapters are generally better suited for drifting, tunneling & extension applications where high bending stresses are present.
- Female shank adapters are used when the drilling space is limited and the total feed length is important (i.e., underground roof bolting).

Two flushing options, internal or external:

- Internal flushing uses a water tube that fits through the centre of the drill and into an o-ring seal in the end of the shank, to transfer flushing into the drill string.
- External flushing, holes or a slot are required in the side of the shank adapter. These line up between seals inside the front head or water box of the rockdrill when the shank is installed. Flushing medium is supplied directly to this device and is introduced into the drill string through the shank.

- External flushing is considered superior to internal flushing as greater volumes of flushing agent can be delivered with less risk of leakage and hammer damage from water.
- The shanks for hydraulic drills and some pneumatic drills have external or front head flushing. Hydraulic shanks generally have at least 5 to 14-spline configuration.
- Pneumatic shanks tend to have internal or through flushing and can generally be identified by their lugs or 4-spline configuration.

RST™ SERIES RODS AND BITS

Strength Defined

Boart Longyear has a long history of providing premium Rock Drill and Blast Drilling products for the most demanding conditions. This tradition continues with the introduction of the Robust Standard Thread (RST™) Series percussive rods and bits with industry leading strength and penetration rates. Boart Longyear has responded to industry demands for stronger, more versatile percussive rods and bits by developing the RST Series that incorporates a larger cross-sectional transition area as well as an increased bit skirt length. This delivers improved impact efficiency for faster penetration rates, increased rod tip-off resistance, and less hole deviation.

Superior Productivity and Design

The RST Series rods incorporate a larger cross-sectional transition area for a nearly 45% increase in bending strength. The bit skirt is also extended for improved interface, making rod tip-off events less likely and reducing cost and downtime. The design of the RST Series results in straighter and truer holes with penetration rate increases of up to 20% as compared to a competitive design offering.

Interchangeability

As an additional benefit, the RST Series design allows for interchangeability with standard rods and bits for improved flexibility in the field, unlike the competitive offerings which utilize unique thread designs.

1 LARGER CROSS-SECTIONAL TRANSITION AREA

Increased rod rigidity/strength when used in deviated applications such as scaling. This results in decreased rod tip-offs and increased productivity

2 UNIVERSAL THREAD

Designed to be compatible with both RST™ Series R32 and existing standard R32 products

3 EXTENDED BIT SKIRT

Provides straighter holes with reduced deviation

4 RETRACT OR STRAIGHT TRACK BIT DESIGN (OPTIONAL)

Provides a cleaner, straighter hole as well as easier bit removal in varied ground conditions

5 PREMIUM TUNGSTEN CARBIDE BUTTONS

Delivers extended drilling performance and longer durability by increasing toughness and wear-resistant properties

6 PREMIUM BODY STEEL MATERIAL

Reduces face and body wear and provides uniform wear characteristics, improved button retention and efficient energy transfer

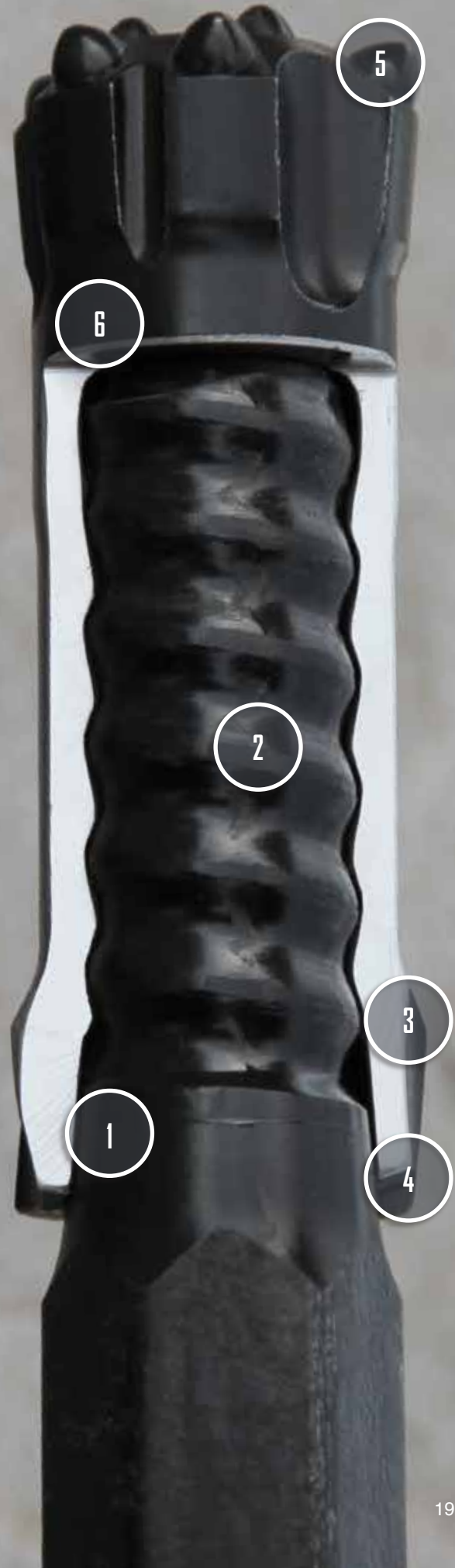

LIGHTNING ROD™ SERIES

Fast Productivity

Boart Longyear has built its reputation by providing innovative Rock Drill and Blast products for specific customer needs. The introduction of our Lightning Rod™ Series for the Surface Drill and Blast percussive market continues this tradition. In response to industry demands, the Lightning Rod Series provides a quick-change male/female rod with high-durability and air flushing. These rods are designed specifically for the surface drill and blast market by focusing on the quick-change properties of male/female configurations and fully treated end-form with a premium steel mid-body. This creates easy coupling and uncoupling, carousel storage and loading, and air flushing. The result is higher productivity and improved efficiency.

Strength Where It Counts

The Lightning Rod Series of Surface Drill and Blast Products utilizes high-strength steel coupled with high-wear resistant ends. The male and female end forms are fully treated to provide market-leading wear resistance during both the drilling process as well as coupling and uncoupling events. Galling, chipping, and surface damage are minimized. The mid-body is comprised of premium steel that has been optimized for maximum air flushing. The Lightning Rod Series also delivers optimum rod compliance for the full range of ground conditions.

Quick to Change

The design configuration of the Lightning Rod Series is a male/female layout that requires no additional coupling. This allows for faster additions or removals to the drill string. The absence of a traditional coupling and optimal geometry is designed for use in top-hammer rod carousel storage and loaders. A wide range of diameters from 33 mm to 60 mm, and lengths from 8 ft to 14 ft provides customers the right size combination for specific project needs.



1 MALE/FEMALE END THREAD FORMS

Eliminates conventional coupling to allow quick, automated subtractions and additions to the drill string

2 TREATED MALE AND FEMALE ENDS

High wear resistance and durability

3 PREMIUM MID-BODY STEEL

Designed for air flushing and optimal rod compliance, the mid-body's structure is strong and durable with efficient energy transfer

4 WIDE RANGE OF SIZES AND THREAD FORMS

Selected to cover multiple project specific needs

HANDHELD DRILLING TOOLS

7° System	22
11° System	23
12° System	25
Rod Shanks	27
Collared Reamer Tools	28
NRT Extension Tools	29
Integral Drilling Tools	29

7° SYSTEM RODS

Collared and Tapered Rods / H22

PART #	LENGTH		WEIGHT	
	MM	FT /IN	KG	LB
250368	600	2'	2.2	4.8
250369	1220	4'	4.0	8.9
250373	1830	6'	5.9	13.0
250234	2440	8'	7.8	17.2
250465	3050	10'	9.7	21.3
250544	3660	12'	11.4	25.2
250537	4270	14'	13.4	29.5
250543	5480	18'	17.2	37.9
250738	6400	21'	20.0	44.0
250540	7320	24'	23.0	50.8
250541	7920	26'	24.9	54.9
250542	9450	31'	29.6	65.3

7° SYSTEM BITS

Tapered Button Bits

PART #	DIAMETER		BUTTONS		FLUSHING HOLE	CARBIDE PROFILE	FACE PROFILE
	MM	IN	GAUGE NO/ SIZE	FRONT NO/ SIZE			
050179	41	1 5/8"	4 x 9	2 x 9	2F 1G	Conical	Flat
050069	33	1 5/16"	5 x 7	2 x 7	1F 1G	Parabolic	Flat
050022	41	1 5/8"	5 x 9	2 x 8	2F 1G	Parabolic	Flat

Tapered Blade Bits

PART #	DIAMETER		FLUSHING HOLE	GAUGE CARBIDE
	MM	IN		
030040	32	1 1/4"	1F 2G	14 x 8
030041	35	1 3/8"	1F 2G	14 x 8
030084	41	1 5/8"	2G	14 x 8
030085	45	1 3/4"	2G	14 x 8

11° SYSTEM RODS

Collared and Tapered Rods / H22

PART #	LENGTH		WEIGHT	
	MM	FT /IN	KG	LB
250183	610	2'	2.2	4.7
250185	760	2' 5 15/16"	2.7	5.8
250160	1220	4'	4.0	8.9
250188	1370	4' 5 15/16"	4.5	10.0
250362	1630	5' 4 3/16"	5.4	11.9
250699	1676	5' 6"	5.5	12.2
250161	1830	6'	5.9	13.0
250191	1980	6' 5 15/16"	6.5	14.3
250162	2440	8'	7.8	17.1
250196	2590	8' 5 15/16"	8.5	18.7
250163	3050	10'	9.6	21.1
250198	3200	10' 6"	10.5	23.1
250200	3660	12'	11.4	25.2
250727	4800	15' 9"	15.0	33.0
250516	5600	18' 4 8/16"	17.3	38.2
250517	6400	21'	20.4	45.0

Collared and Tapered Rods – Auger / A22

PART #	LENGTH		WEIGHT	
	MM	FT /IN	KG	LB
310010	1830	6'	8.5	18.8

11° SYSTEM BITS

Tapered Button Bits

PART #	DIAMETER		BUTTONS		FLUSHING HOLE	CARBIDE PROFILE	FACE PROFILE
	MM	IN	GAUGE NO/ SIZE	FRONT NO/ SIZE			
050114	32	1 1/4"	3 x 8	2 x 7	1F 2G	Conical	Flat
050118	34	1 11/32"	3 x 8	2 x 7	1F 2G	Conical	Flat
050222	48	1 7/8"	3 x 9	2 x 9	1F 2G	Conical	Flat
050172	34	1 11/32"	4 x 7	2 x 7	2F 1G	Conical	Flat

11° SYSTEM BITS

Tapered Button Bits

PART #	DIAMETER		BUTTONS		FLUSHING HOLE	CARBIDE PROFILE	FACE PROFILE
	MM	IN	GAUGE NO/ SIZE	FRONT NO/ SIZE			
050141	32	1 1/4"	5 x 7	2 x 7	1F 1G	Parabolic	Flat



050122	36	1 13/32"	5 x 8	2 x 7	2F 1G	Conical	Flat
050130	38	1 1/2"	5 x 9	2 x 7	2F 1G	Conical	Flat
050145	38	1 1/2"	5 x 9	2 x 7	2F 1G	Conical	Flat
050220	40	1 9/16"	5 x 9	2 x 8	2F 1G	Conical	Flat
050175	41	1 5/8"	5 x 9	2 x 8	2F 1G	Conical	Flat
050146	41	1 5/8"	5 x 9	2 x 8	2F 1G	Parabolic	Flat



050226	33	1 5/16"	6 x 7	2 x 7	2F 1G	Conical	Flat
--------	----	---------	-------	-------	-------	---------	------



Tapered Blade Bits

PART #	DIAMETER		FLUSHING HOLE	GAUGE CARBIDE
	MM	IN		
030099	38	1 1/2"	1F 4G	7 x 8



12° SYSTEM RODS

Collared and Tapered Rods / H22

PART #	LENGTH		WEIGHT	
	MM	FT /IN	KG	LB
250365	300	1'	1.1	2.5
250118	610	2'	2.2	4.7
250473	800	2' 7 8/16"	2.7	6.0
250440	910	3'	3.1	6.8
250119	1220	4'	4.0	8.9
250187	1370	4' 5 15/16"	4.5	9.9
250189	1520	5'	5.0	11.0
250063	1600	5' 3"	5.4	11.8
250441	1670	5' 5 12/16"	5.5	12.1
250120	1830	6'	5.9	13.0
250190	1980	6' 5 15/16"	6.5	14.3
250447	2400	7' 10 8/16"	7.6	16.8
250121	2440	8'	7.6	16.8
250195	2590	8' 5 15/16"	8.5	18.7
250122	3050	10'	9.6	21.1
250374	3200	10' 6"	9.9	21.8
250123	3660	12'	11.4	25.2
250448	4000	13' 1 8/16"	12.6	27.7
250201	4270	14'	14.0	30.8
250364	5480	18'	17.0	37.4
250387	6700	22'	21.3	47.0

Collared and Tapered Rods – Auger / A22

PART #	LENGTH		WEIGHT	
	MM	FT /IN	KG	LB
310001	610	2'	3.3	7.2
310003	1220	4'	5.9	13.0
310005	1830	6'	8.5	18.8
310007	2440	8'	11.2	24.6
310009	3050	10'	13.8	30.4
310012	3660	12'	14.0	30.8

12° SYSTEM BITS

Tapered Button Bits

PART #	DIAMETER		BUTTONS		FLUSHING HOLE	CARBIDE PROFILE	FACE PROFILE	
	MM	IN	GAUGE NO/ SIZE	FRONT NO/ SIZE				
 	050228	28	1 1/8"	4 x 7	1 x 7	2G	Conical	Flat
	050081	28	1 1/8"	4 x 7	1 x 7	2G	Hemispherical	Flat
 	050241	37	1 15/32	6 x 8	2 x 7	2F	Parabolic	Flat
 	050096	32	1 1/4"	5 x 7	2 x 7	2F 1G	Parabolic	Flat
	050181	32	1 1/4"	5 x 7	2 x 7	2F 1G	Conical	Flat
	050177	33	1 5/16"	5 x 7	2 x 7	2F 1G	Conical	Flat
 	050244	35	1 3/8	5 x 8	2 x 7	2G	Parabolic	Flat
 	050036	35	1 3/8"	5 x 8	2 x 7	1F 2G	Hemispherical	Flat
	050066	38	1 1/2"	5 x 8	2 x 7	1F 2G	Hemispherical	Flat
	050254	41	1 5/8"	5 x 9	2 x 7	1F 2G	Parabolic	Flat
	050068	45	1 3/4"	5 x 9	2 x 9	1F 2G	Hemispherical	Flat
	050242	41	1 5/8"	5 x 9	2 x 8	2F 1G	Parabolic	Flat
 	050109	32	1 1/4"	6 x 7	2 x 7	2F 1G	Conical	Flat
	050111	32	1 1/4"	6 x 7	2 x 7	2F 1G	Conical	Flat
 	050234	33	1 5/16"	6 x 7	2 x 7	2F 1G	Parabolic	Flat

12° SYSTEM BITS

Tapered Button Bits



PART #	DIAMETER		BUTTONS		FLUSHING HOLE	CARBIDE PROFILE	FACE PROFILE
	MM	IN	GAUGE NO/ SIZE	FRONT NO/ SIZE			
050225	37	1 15/32"	6 x 8	2 x 8	1F 1G	Parabolic	Dome

Tapered Blade Bits



PART #	DIAMETER		GAUGE CARBIDE	FLUSHING HOLE
	MM	IN		
030003	28	1 1/8"	14 X 8	1F 2G
030113	30	1 3/16"	15 X 8	1F 2G
030115	32	1 1/4"	15 X 8	1F 2G
030032	32	1 1/4"	14 X 8	1F 2G
030037	38	1 1/2"	14 X 8	1F 2G
030039	45	1 3/4"	14 X 8	1F 2G



030110	35	1 3/8"	14 X 8	4G
--------	----	--------	--------	----

ROD SHANKS

Rod Shanks – R25 Thread / 22H



PART #	LENGTH		WEIGHT	
	MM	FT / IN	KG	LB

240045	254	0' 10"	1.1	2.5
240137	310	1' 3/16"	1.2	2.7
240160	350	1' 1 12/16"	1.2	2.6
240022	610	2'	2.4	5.2
240046	800	2' 7 8/16"	3.0	6.6
240145	1220	4'	4.2	9.2
240164	1830	6'	5.9	13.0
240020	2440	8'	8.0	17.7
240095	3200	10' 6"	10.2	22.5

ROD SHANKS

Rod Shanks – R25 Thread / 25H



PART #	LENGTH		WEIGHT	
	MM	FT / IN	KG	LB
240035	610	2'	2.9	6.4
240050	1220	4'	5.4	11.8
240037	1830	6'	7.8	17.2
240038	2440	8'	10.3	22.6
240096	3600	11' 9 12/16"	14.5	31.9

COLLARED REAMER TOOLS

Collared Reamer Rods – 6.5° / 22H



PART #	LENGTH		WEIGHT	
	MM	FT / IN	KG	LB
260001	610	2'	2.2	4.8
260002	1220	4'	4.2	9.2
260016	1520	5'	5.5	12.2
260003	1830	6'	6.3	13.8
260021	2000	6' 6 12/16"	6.5	14.3
260004	2440	8'	8.4	18.4
260015	3050	10'	10.3	22.8

Reamer Bits – 6.5°



PART #	DIAMETER		BUTTONS		CARBIDE PROFILE	FACE PROFILE
	MM	IN	GAUGE NO/ SIZE	FRONT NO/ SIZE		
070021	62	2 7/16"	8 x 11	2 x 10	Hemispherical	Flat
070022	76	3"	8 x 11	2 x 11	Hemispherical	Flat

NRT EXTENSION TOOLS

NRT Extension Rods / H22

PART #	LENGTH		WEIGHT	
	MM	FT /IN	KG	LB
200171	610	2'	1.9	4.2
200190	1220	4'	3.8	8.3

NRT Coupling – Semi-Bridge

PART #	DIAMETER		LENGTH		THREAD	WEIGHT	
	MM	IN	MM	IN		KG	LB
350010	35	1 3/8"	108	4 1/4"	NRT	0.4	0.9



INTEGRAL DRILLING TOOLS

Integral Drill Steels – Series 12 / H22

PART #	LENGTH		WEIGHT		BIT DIAMETER	
	MM	FT /IN	KG	LB	MM	IN
07140840-11	800	2' 7 8/16"	3.0	6.6	40	1 5/8"
07141639-11	1600	5' 3"	5.0	11.0	39	1 17/32"
07142438-11	2400	7' 10 8/16"	7.0	15.4	38	1 1/2"
07143237-11	3200	10' 6"	10.0	22.0	37	1 29/64"
07144036-11	4000	13' 1 8/16"	12.6	27.8	36	1 27/64"
07144835-11	4800	15' 9"	15.0	33.0	35	1 3/8"
07145634-11	5600	18' 4 8/16"	17.0	37.4	34	1 11/32"

Integral Drill Steels – Series 17 / H22

PART #	LENGTH		WEIGHT		BIT DIAMETER	
	MM	FT /IN	KG	LB	MM	IN
07140641-11	600	1' 11 10/16"	2.0	4.4	41	1 5/8"
07141240-11	1200	3' 11 4/16"	4.0	8.8	40	1 9/16"
07141839-11	1800	5' 10 14/16"	6.0	13.2	39	1 17/32"



TUNNELING | DRIFTING | LONGHOLE DRILLING TOOLS

R23 System	32
R25 System	33
R28 System	36
R32 System	38
R35 System	47
HM35 (T35) System	50
R38 System	51
HM38 (T38) System	53
HM45 (T45) System	59
HM51 (T51) System	66
BE58 System	71
EL60 System	73
BE68 System	76
EL68 System	78

R23 SYSTEM RODS

Tunneling / Drifting MM Rods

PART #	LENGTH		ROD CROSS SECTION	THREAD		WEIGHT	
	MM	FT/IN		BIT END	ROD END	KG	LB
220431	2440	8'	25H	R23	R32	99	217

R23 SYSTEM BITS

Button Bits

PART #	DIAMETER		BUTTONS		FLUSHING HOLE	CARBIDE PROFILE	FACE PROFILE
	MM	IN	GAUGE NO/ SIZE	FRONT NO/ SIZE			
110653	33	1 5/16"	5 x 7	2 x 7	1F 2G	Hemispherical	Flat
110477	35	1 3/8"	5 x 8	2 x 7	1F 2G	Hemispherical	Flat
110600	38	1 1/2"	5 x 8	2 x 7	1F 2G	Hemispherical	Flat



R25 SYSTEM RODS

Tunneling / Drifting MM Rods

PART #	LENGTH		ROD CROSS SECTION	THREAD		WEIGHT	
	MM	FT/IN		BIT END	ROD END	KG	LB
220179	2150	7' 10/16"	25H	R25	R32	9.0	19.8
220262	2290	7' 6 3/16"	25H	R25	R32	9.2	20.3
220219	2430	8'	25H	R25	R32	10.4	22.9
220202	2590	8' 5 15/16"	25H	R25	R32	10.7	23.6
220404	2600	8' 6 6/16"	25H	R25	R32	10.9	24.0
220420	2700	8' 10 5/16"	25H	R25	R32	11.1	24.5
220286	2800	9' 2 4/16"	25H	R25	R32	11.3	25.0
220287	2900	9' 6 3/16"	25H	R25	R32	11.6	25.6
220303	3090	10' 1 10/16"	25H	R25	R32	12.3	27.0
220309	3700	12' 1 11/16"	25H	R25	R32	14.7	32.5
220498	4000	13' 1 8/16"	25H	R25	R32	15.9	35.0



220441	2300	7' 6 9/16"	28H	R25	R32	11.6	25.6
220443	2800	9' 2 4/16"	28H	R25	R32	13.8	30.3
220138	3100	10' 2 1/16"	28H	R25	R32	15.3	33.7
220229	3200	10' 6"	28H	R25	R32	16.0	35.3
220444	3400	11' 1 14/16"	28H	R25	R32	17.0	37.5

Long Hole MM Rods

PART #	WRENCH FLATS	LENGTH		ROD CROSS SECTION	THREAD	WEIGHT	
		MM	FT/IN			KG	LB
200496	No	610	2'	25H	R25	2.2	4.8
200376	No	910	3'	25H	R25	3.2	7.1
200474	No	1000	3' 3 6/16"	25H	R25	3.7	8.1
200102	No	1220	4'	25H	R25	4.8	10.5
203009	No	1520	5'	25H	R25	5.8	12.9
200106	No	1830	6'	25H	R25	6.7	14.7
200378	No	2440	8'	25H	R25	9.3	20.5

Long Hole MF Rods

PART #	WRENCH FLATS	LENGTH		ROD CROSS SECTION	THREAD	WEIGHT	
		MM	FT/IN			KG	LB
210139	No	800	2' 7 8/16"	25H	R25	3.9	8.5
210208	No	910	3'	25H	R25	3.9	8.6
210209	No	1220	4'	25H	R25	5.0	11.0
210200	No	1525	5'	25H	R25	6.3	14.0
210160	No	1830	6'	25H	R25	7.2	15.9

R25 SYSTEM BITS

Button Bits

PART #	DIAMETER		BUTTONS		FLUSHING HOLE	CARBIDE PROFILE	FACE PROFILE
	MM	IN	GAUGE NO/ SIZE	FRONT NO/ SIZE			
110691	33	1 5/16"	5 x 7	2 x 7	1F 3G	Parabolic	Flat
110284	33	1 5/16"	5 x 7	2 x 7	1F 1G	Hemispherical	Flat
110580	35	1 3/8"	5 x 9	2 x 7	1F 1G	Hemispherical	Dome
110822	35	1 3/8"	5 x 9	2 x 7	1F 1G	Parabolic	Dome
110930	35	1 3/8"	5 x 8	2 x 7	2G	Hemispherical	Flat
110236	35	1 3/8"	5 x 8	2 x 7	1F 2G	Hemispherical	Flat
110973	38	1 1/2"	5 x 9	2 x 7	1F 2G	Ballistic / Parabolic	Flat
110442	38	1 1/2"	5 x 8	2 x 7	1F 2G	Hemispherical	Flat
110423	38	1 1/2"	5 x 8	2 x 7	1F 2G	Parabolic	Flat
110003	38	1 1/2"	5 x 9	2 x 7	1F 2G	Hemispherical	Flat
110962	41	1 5/8"	5 x 10	2 x 9	1F 2G	Ballistic	Flat
110169	41	1 5/8"	5 x 10	2 x 8	1F 2G	Hemispherical	Flat
110476	45	1 3/4"	5 x 10	2 x 9	1F 2G	Hemispherical	Flat
110821	48	1 7/8"	5 x 11	2 x 9	1F 2G	Parabolic	Flat
110986	34	1 11/32"	5 x 8	2 x 7	1F 3G	Conical	Flat
110749	37	1 15/32"	6 x 8	2 x 7	2F 1G	Parabolic	Flat
110690	38	1 1/2"	6 x 8	2 x 8	2F 1G	Parabolic	Flat
110684	48	1 7/8"	6 x 9	3 x 8	3F 1G	Hemispherical	Flat

R25 SYSTEM BITS

Blade Bits



PART #	DIAMETER		GAUGE CARBIDE	FLUSHING HOLE
	MM	IN		
120208	38	1 1/2"	16 x 9	1F 4G
120213	41	1 5/8"	18 x 10	1F 4G
120225	45	1 3/4"	21 x 11	1F 4G
120258	48	1 7/8"	16 x 9	1F 4G

R25 SYSTEM REAMING TOOLS

6° Pilot Adapter



PART #	PILOT DIAMETER		PILOT LENGTH		FLUSHING HOLE	WEIGHT		THREAD
	MM	IN	MM	IN		KG	LB	
380015	26	1 1/32"	254	10	3F	14	3.1	R25

6° Hemispherical Buttons Reaming Bits

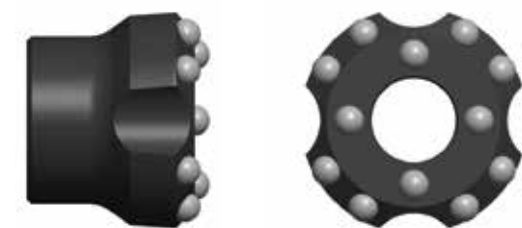

PART #	DIAMETER		BUTTONS		CARBIDE PROFILE	WEIGHT	
	MM	IN	GAUGE NO/ SIZE	FRONT NO/ SIZE		KG	LB
070020	57	2 1/4	8 x 9	2 x 9	Hemispherical	1.1	2.4
070009	76	3	8 x 10	4 x 10	Hemispherical	1.3	2.8
070011	89	3 1/2	8 x 10	4 x 10	Hemispherical	1.7	3.7

R25 SYSTEM COUPLING

Semi-Bridge Couplings



PART #	DIAMETER		LENGTH		THREAD	WEIGHT	
	MM	IN	MM	IN		KG	LB
350054	33	1 5/16"	150	6	R25	0.6	1.3
350005	35	1 3/8"	150	6	R25	0.6	1.4

R28 SYSTEM RODS

Tunneling / Drifting MM Rods

PART #	LENGTH		ROD CROSS SECTION	THREAD		WEIGHT		
	MM	FT/IN		BIT END	ROD END	KG	LB	
								
220296	1900	6' 2 13/16"	28H	R28	R32	9.2	20.4	
220194	2480	8' 1 10/16"	28H	R28	R32	12.2	26.8	
220242	2590	8' 5 15/16"	28H	R28	R32	12.7	28.0	
220265	2700	8' 10 5/16"	28H	R28	R32	13.2	29.0	
220198	2800	9' 2 4/16"	28H	R28	R32	14.0	30.9	
220068	3090	10' 1 10/16"	28H	R28	R32	14.7	32.5	
220075	3700	12' 11/16"	28H	R28	R32	18.2	40.0	
220449	4300	14' 1 5/16"	28H	R28	R32	21.5	47.3	

								
220024	4300	14' 1 5/16"	32H	R28	R38	27.8	61.2	

Long Hole MM Rods

PART #	WRENCH FLATS	LENGTH		ROD CROSS SECTION	THREAD	WEIGHT		
		MM	FT/IN			KG	LB	
								
200516	No	2060	6' 9 7/64"	28H	R28	10.8	23.9	

Long Hole MF Rods

PART #	WRENCH FLATS	LENGTH		ROD CROSS SECTION	THREAD	WEIGHT		
		MM	FT/IN			KG	LB	
								
210151	No	686	2' 3"	28H	R28	3.8	8.4	
210132	No	1520	5'	28H	R28	8.5	18.8	

R28 SYSTEM BITS

Button Bits



PART #	DIAMETER		BUTTONS		FLUSHING HOLE	CARBIDE PROFILE	FACE PROFILE
	MM	IN	GAUGE NO/ SIZE	FRONT NO/ SIZE			
110527	36	1 7/16"	5 x 8	2 x 7	1F 2G	Hemispherical	Flat
110818	37	1 15/32"	5 x 8	2 x 7	1F 2G	Hemispherical	Flat
110904	37	1 15/32"	5 x 9	2 x 7	1F 2G	Parabolic	Flat
110002	38	1 1/2"	5 x 9	2 x 7	1F 2G	Hemispherical	Flat
110611	38	1 1/2"	5 x 9	2 x 7	1F 2G	Hemispherical	Flat
110495	38	1 1/2"	5 x 9	2 x 7	1F 2G	Parabolic	Flat
110167	38	1 1/2"	5 x 9	2 x 7	1F 2G	Hemispherical	Flat
110006	41	1 5/8"	5 x 10	2 x 8	1F 2G	Hemispherical	Flat
110576	41	1 5/8"	5 x 10	2 x 8	1F 2G	Parabolic	Flat
110118	45	1 3/4"	5 x 10	2 x 9	1F 2G	Hemispherical	Flat
110323	48	1 7/8"	5 x 11	2 x 9	1F 2G	Hemispherical	Flat
110775	51	2"	5 x 11	2 x 10	1F 2G	Hemispherical	Flat
110820	51	2"	5 x 11	2 x 10	1F 2G	Parabolic	Flat

R28 SYSTEM REAMER TOOLS

6° Reamer Pilot Adapter



PART #	PILOT DIAMETER		PILOT LENGTH		FLUSHING HOLE	WEIGHT		THREAD
	MM	IN	MM	IN		KG	LB	
380003	26	1 1/32"	266	10 8/16"	3F	1.6	3.5	R28

6° Reamer Buttons Bits

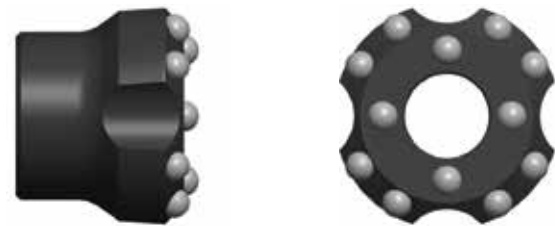

PART #	DIAMETER		BUTTONS		CARBIDE PROFILE	WEIGHT	
	MM	IN	GAUGE NO/ SIZE	FRONT NO/ SIZE		KG	LB
070020	57	2 1/4"	8 x 9	2 x 9	Hemispherical	1.1	2.4
070009	76	3"	8 x 10	4 x 10	Hemispherical	1.3	2.8
070011	89	3 1/2"	8 x 10	4 x 10	Hemispherical	1.7	3.7

R28 SYSTEM COUPLINGS













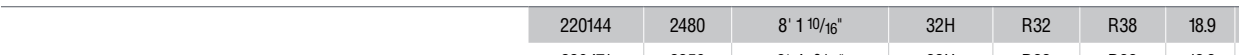

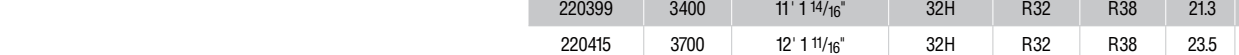
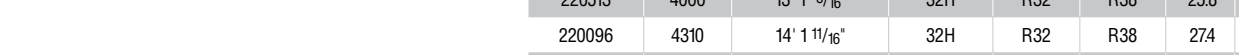



Semi-Bridge Couplings



PART #	DIAMETER		LENGTH		THREAD	WEIGHT	
	MM	IN	MM	IN		KG	LB
350033	40	1 9/16"	150	6	R28	0.8	1.8

R32 SYSTEM RODS

Tunneling / Drifting MM Rods

PART #	LENGTH		ROD CROSS SECTION	THREAD		WEIGHT		
	MM	FT/IN		BIT END	ROD END	KG	LB	
	220257	3700	12' 1 11/16"	32H	R32	R32	23.5	51.9
	220484	1830	6'	25H	R32	R32	23.5	51.9
	220144	2480	8' 1 10/16"	32H	R32	R38	18.9	41.6
	220471	2850	9' 4 3/16"	32H	R32	R38	18.3	40.4
	220414	3090	10' 1 10/16"	32H	R32	R38	19.1	42.0
	220483	3200	10' 6"	32H	R32	R38	20.0	44.0
	220399	3400	11' 1 14/16"	32H	R32	R38	21.3	47.0
	220415	3700	12' 1 11/16"	32H	R32	R38	23.5	51.9
	220513	4000	13' 1 8/16"	32H	R32	R38	25.8	56.9
	220096	4310	14' 1 11/16"	32H	R32	R38	27.4	60.4
	220112	4915	16' 1 8/16"	32H	R32	R38	30.2	66.6
	220152	3090	10' 1 10/16"	32H	R32	HM38	19.1	42
	220400	3700	12' 1 11/16"	32H	R32	HM38	23.6	52.0
	220095	4310	14' 1 11/16"	32H	R32	HM38	26.7	58.9
	220157	4915	16' 1 8/16"	32H	R32	HM38	30.5	67.2
	220271	2480	8' 1 10/16"	35H	R32	R38	18.5	40.8
	220277	2700	8' 10 5/16"	35H	R32	R38	20.4	45.0
	220159	3090	10' 1 10/16"	35H	R32	R38	23.1	51.0
	220161	3700	12' 1 11/16"	35H	R32	R38	27.9	61.6
	220100	4310	14' 1 11/16"	35H	R32	R38	32.9	72.5
	220115	4915	16' 1 8/16"	35H	R32	R38	37.0	81.6
	220038	5525	18' 1 8/16"	35H	R32	R38	42.4	93.5

R32 SYSTEM RODS



Tunneling / Drifting MM Rods

PART #	LENGTH		ROD CROSS SECTION	THREAD		WEIGHT	
	MM	FT/IN		BIT END	ROD END	KG	LB
							
220292	2400	7' 10 8/16"	35H	R32	HM38	18.5	40.7
220497	2700	8' 10 5/16"	35H	R32	HM38	21.0	46.3
220164	3090	10' 1 10/16"	35H	R32	HM38	24.1	53.1
220166	3700	12' 1 11/16"	35H	R32	HM38	28.2	62.2
220209	4300	14' 1 5/16"	35H	R32	HM38	32.9	72.5
220384	4500	14' 9 3/16"	35H	R32	HM38	35.4	78.0
220170	4915	16' 1 8/16"	35H	R32	HM38	37.2	81.9
220042	5520	18' 5/16"	35H	R32	HM38	42.2	93.0
220494	6135	20' 1 9/16"	35H	R32	HM38	48.0	105.9
220464	6400	21'	35H	R32	HM38	50.8	112.0

Tunneling / Drifting MF Rods



PART #	LENGTH		ROD CROSS SECTION	THREAD		WEIGHT	
	MM	FT/IN		BIT END	ROD END	KG	LB
							
300022	3100	10' 2 1/16"	35H	R32	HM38	26.5	58.4
300010	3700	12' 1 11/16"	35H	R32	HM38	30.0	66.1
300012	4310	14' 1 11/16"	35H	R32	HM38	34.5	76.1
300036	4915	16' 1 8/16"	35H	R32	HM38	39.6	87.3
300039	5525	18' 1 8/16"	35H	R32	HM38	44.7	98.5

Tunneling / Drifting RST™ MM Rods

PART #	LENGTH		ROD CROSS SECTION	THREAD		WEIGHT	
	MM	FT/IN		BIT END	ROD END	KG	LB
							
220508	3090	10' 1 10/16"	35H	R32	R38	23.8	52.5
220503	3700	12' 1 11/16"	35H	R32	R38	28.4	62.7
220507	4310	14' 1 11/16"	35H	R32	R38	34.3	75.6
							
220523	3090	10' 1 10/16"	35H	R32	HM38	24.2	53.2
220510	3700	12' 1 11/16"	35H	R32	HM38	27.7	61.1
220502	4310	14' 1 11/16"	35H	R32	HM38	33.8	74.5
220500	4915	16' 1 8/16"	35H	R32	HM38	38.5	84.9
220501	5525	18' 1 8/16"	35H	R32	HM38	43.3	95.5

R32 SYSTEM RODS

Long Hole MM Rods

PART #	WRENCH FLATS	LENGTH		ROD CROSS SECTION	THREAD	WEIGHT		
		MM	FT/IN			KG	LB	
								
200476	Yes	1000	3' 3 6/16"	25H	R32	5.2	11.4	
								
200169	No	200	0' 7 14/16"	33R	R32	1.3	2.9	
200500	Yes	915	3'	33R	R32	5.2	11.4	
200481	Yes	1000	3' 3 6/16"	33R	R32	5.7	12.5	
200401	Yes	1220	4'	33R	R32	6.6	14.6	
200483	Yes	1830	6'	33R	R32	9.9	21.8	
200357	Yes	2000	6' 6 12/16"	33R	R32	10.8	23.9	
200456	Yes	2440	8'	33R	R32	13.3	29.4	
200484	Yes	3050	10'	33R	R32	16.7	36.9	
200372	No	3660	12'	33R	R32	20.1	44.3	
200259	No	4000	13' 1 8/16"	33R	R32	21.6	47.6	
200034	No	4270	14'	33R	R32	23.5	51.8	
200541	No	5480	17' 11 3/4"	33R	R32	28.7	63.3	

Long Hole MF Rods

PART #	WRENCH FLATS	LENGTH		ROD CROSS SECTION	THREAD	WEIGHT		
		MM	FT/IN			KG	LB	
								
210068	No	910	3'	33R	R32	5.4	12.0	
210023	No	1220	4'	33R	R32	7.3	16.0	
210004	No	1525	5'	33R	R32	9.0	19.8	
210005	No	1830	6'	33R	R32	10.8	23.7	
210051	No	2440	8'	33R	R32	14.3	31.6	
210006	No	3050	10'	33R	R32	17.9	39.5	
210107	Yes	3050	10'	33R	R32	17.9	39.5	
210050	No	3660	12'	33R	R32	20.7	45.5	
210115	Yes	3660	12'	33R	R32	20.7	45.5	

Long Hole MF Retrac Rods

PART #	WRENCH FLATS	LENGTH		ROD CROSS SECTION	THREAD	WEIGHT		
		MM	FT/IN			KG	LB	
								
210073	No	1220	4'	32H	R32	7.3	16.0	

R32 SYSTEM RODS

Long Hole MF 54mm Guide Rods

PART #	WRENCH FLATS	LENGTH		ROD CROSS SECTION	THREAD	WEIGHT	
		MM	FT/IN			KG	LB
280034	No	1220	4'	35H	R32	10.8	23.8



Long Hole MF Guide Tubes

PART #	WRENCH FLATS	LENGTH		ROD CROSS SECTION	THREAD	WEIGHT	
		MM	FT/IN			KG	LB
270083	Yes	1525	5'	44T	R32	27.3	60.2
270059	Yes	3050	10'	44T	R32	24.3	53.5



Long Hole MF Drill Tubes

PART #	WRENCH FLATS	LENGTH		ROD CROSS SECTION	THREAD	WEIGHT	
		MM	FT/IN			KG	LB
270084	No	1525	5'	46R	R32	14.9	32.8



R32 SYSTEM BITS

Button Bits

PART #	DIAMETER		BUTTONS		FLUSHING HOLE	CARBIDE PROFILE	FACE PROFILE
	MM	IN	GAUGE NO/ SIZE	FRONT NO/ SIZE			
110127	57	2 1/4"	6 x 10	3 x 9	1F 1G	Hemispherical	Flat
110024	64	2 1/2"	6 x 13	3 x 10	1F 1G	Hemispherical	Flat
110188	51	2	4 x 12	2 x 9	1F 1G	Hemispherical	Chisel

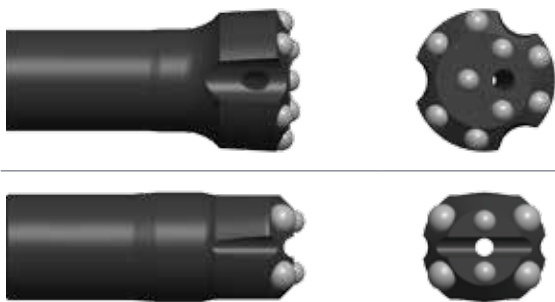

R32 SYSTEM BITS

Button Bits



PART #	DIAMETER		BUTTONS		FLUSHING HOLE	CARBIDE PROFILE	FACE PROFILE
	MM	IN	GAUGE NO/ SIZE	FRONT NO/ SIZE			
110875	43	1 11/16"	5 x 10	2 x 9	1F 2G	Hemispherical	Flat
110597	41	1 5/8"	5 x 9	2 x 8	1F 2G	Hemispherical	Flat
110545	42	1 21/32"	5 x 10	2 x 8	1F 2G	Parabolic	Flat
110176	43	1 11/16"	5 x 10	2 x 8	1F 2G	Hemispherical	Flat
110180	45	1 3/4"	5 x 11	2 x 8	1F 2G	Hemispherical	Flat
110765	45	1 3/4"	5 x 11	2 x 9	1F 2G	Hemispherical	Flat
110892	45	1 3/4"	5 x 11	2 x 9	1F 2G	Hemispherical	Flat
110285	45	1 3/4"	5 x 11	2 x 8	1F 2G	Parabolic	Flat
110368	45	1 3/4"	5 x 10	2 x 9	1F 2G	Parabolic	Flat
110772	45	1 3/4"	5 x 11	2 x 9	1F 2G	Parabolic	Flat
110179	45	1 3/4"	5 x 10	2 x 9	1F 2G	Hemispherical	Flat
110251	48	1 7/8"	5 x 11	2 x 9	1F 2G	Hemispherical	Flat
110184	48	1 7/8"	5 x 11	2 x 9	1F 2G	Hemispherical	Flat
110919	48	1 7/8"	5 x 11	2 x 9	1F 2G	Hemispherical	Flat
110609	48	1 7/8"	5 x 11	2 x 9	1F 2G	Parabolic	Flat
110988	51	2"	5 x 11	2 x 10	1F 2G	Hemispherical	Flat
110472	51	2"	5 x 11	2 x 10	1F 2G	Parabolic	Flat
110754	51	2"	5 x 12	2 x 10	1F 2G	Parabolic	Flat
110777	51	2"	5 x 12	2 x 11	1F 2G	Parabolic	Flat
110429	57	2 1/4"	6 x 11	3 x 10	1F 2G	Parabolic	Flat
110131	64	2 1/2"	6 x 12	3 x 10	1F 2G	Hemispherical	Flat
110135	76	3"	6 x 12	5 x 10	1F 2G	Hemispherical	Flat
110034	76	3"	8 x 11	6 x 11	2F	Hemispherical	Dome
110038	89	3 1/2"	8 x 11	6 x 11	2F	Hemispherical	Dome
110708	41	1 5/8"	6 x 8	2 x 8	2F 1G	Parabolic	Flat
110646	43	1 11/16"	6 x 9	2 x 8	2F 1G	Parabolic	Flat
110517	64	2 1/2"	8 x 10	4 x 10	2F 1G	Parabolic	Flat
110876	45	1 3/4"	5 x 11	2 x 8	2F 2G	Hemispherical	Flat

R32 SYSTEM BITS

Button Bits

PART #	DIAMETER		BUTTONS		FLUSHING HOLE	CARBIDE PROFILE	FACE PROFILE	
	MM	IN	GAUGE NO/ SIZE	FRONT NO/ SIZE				
 	110770	45	1 3/4"	6 x 9	2 x 9	2F 2G	Ballistic	Flat
	110615	51	2"	6 x 11	2 x 11	2F 2G	Hemispherical	Flat
 	110566	45	1 3/4"	6 x 9	3 x 8	3F	Hemispherical	Flat
	110591	45	1 3/4"	6 x 9	3 x 8	3F	Hemispherical	Flat
 	110730	51	2"	6 x 10	3 x 9	3F	Parabolic	Flat
	110657	57	2 1/4"	6 x 11	3 x 10	3F	Parabolic	Flat
	110448	57	2 1/4"	6 x 11	3 x 10	3F	Hemispherical	Flat
	110997	43	1 11/16"	6 x 9	3 x 8	3F 1G	Hemispherical	Flat
 	110664	45	1 3/4"	6 x 9	3 x 8	3F 1G	Parabolic	Flat
	110375	45	1 3/4"	6 x 9	3 x 9	3F 1G	Hemispherical	Flat
	110526	45	1 3/4"	6 x 9	3 x 8	3F 1G	Parabolic	Flat
	110898	48	1 7/8"	6 x 10	3 x 8	3F 1G	Conical	Flat
	110516	48	1 7/8"	6 x 9	3 x 8	3F 1G	Parabolic	Flat
	110552	51	2"	6 x 10	3 x 9	3F 1G	Hemispherical	Flat
	110515	51	2"	6 x 10	3 x 9	3F 1G	Parabolic	Flat
	110748	54	2 1/8"	6 x 10	3 x 9	3F 1G	Hemispherical	Flat
	110914	64	2 1/2"	6 x 11	3 x 10	3F 1G	Hemispherical	Flat
	110778	64	2 1/2"	6 x 11	3 x 10	3F 1G	Parabolic	Flat
	110799	76	3"	6 x 12	4 x 10	3F 1G	Hemispherical	Flat
 	110800	89	3 1/2"	6 x 14	4 x 12	3F 1G	Hemispherical	Flat
	110996	43	1 11/16"	6 x 9	3 x 8	3F 2G	Hemispherical	Flat

Blade Bits



PART #	DIAMETER		GAUGE CARBIDE	FLUSHING HOLE	
	MM	IN			
 	120329	41	1 5/8"	16 x 9	1F 4G
	120223	43	1 11/16"	18 x 10	1F 4G
	120255	45	1 3/4"	21 x 11	1F 4G
	120045	45	1 3/4"	21 x 11	1F 4G
	120304	51	2"	22 x 12	1F 4G
	120051	51	2"	26 x 12	1F 4G

R32 SYSTEM BITS



Retrac Button Bits

PART #	DIAMETER		BUTTONS		FLUSHING HOLE	CARBIDE PROFILE	FACE PROFILE
	MM	IN	GAUGE NO/ SIZE	FRONT NO/ SIZE			
 130098	51	2"	6 x 10	3 x 9	3F 1RF	Hemispherical	Flat
130048	54	2 1/8"	6 x 10	3 x 10	3F 1RF	Parabolic	Flat
130056	64	2 1/2"	6 x 13	3 x 10	3F 1RF	Hemispherical	Flat

Straightrac Button Bits

PART #	DIAMETER		BUTTONS		FLUSHING HOLE	CARBIDE PROFILE	FACE PROFILE
	MM	IN	GAUGE NO/ SIZE	FRONT NO/ SIZE			
 140028	51	2"	6 x 10	3 x 9	3F	Hemispherical	Flat
140137	51	2"	6 x 10	3 x 9	3F	Parabolic	Flat
140029	57	2 1/2"	6 x 11	3 x 9	3F	Hemispherical	Flat
 140074	51	2"	6 x 9	3 x 9	3F 1G	Hemispherical	Flat
140030	64	2 1/2"	6 x 11	3 x 10	3F 1G	Hemispherical	Flat

RST™ Button Bits





PART #	DIAMETER		BUTTONS		FLUSHING HOLE	CARBIDE PROFILE	FACE PROFILE
	MM	IN	GAUGE NO/ SIZE	FRONT NO/ SIZE			
 110953	43	1 11/16"	5 x 10	2 x 9	1F 2G	Hemispherical	Flat
110958	45	1 3/4"	5 x 10	2 x 9	1F 2G	Hemispherical	Flat
 110960	51	2"	6 x 11	2 x 11	2F 2G	Hemispherical	Flat
 110956	45	1 3/4"	6 x 10	3 x 8	3F 1G	Parabolic	Flat
110959	48	1 7/8"	6 x 10	3 x 8	3F 1G	Parabolic	Flat
110961	51	2"	6 x 10	3 x 9	3F 1G	Parabolic	Flat

RST™ Straightrac Button Bits

PART #	DIAMETER		BUTTONS		FLUSHING HOLE	CARBIDE PROFILE	FACE PROFILE
	MM	IN	GAUGE NO/ SIZE	FRONT NO/ SIZE			
 140196	45	1 3/4"	6 x 10	3 x 8	3F 1G	Hemispherical	Flat
140197	45	1 3/4"	6 x 10	3 x 8	3F 1G	Parabolic	Flat
140208	45	1 3/4"	6 x 10	3 x 8	3F 1G	Parabolic	Flat

R32 SYSTEM REAMER TOOLS

Pilot Reamer Bits

PART #	DIAMETER		PILOT DIAMETER		BUTTONS		FLUSHING HOLE	CARBIDE PROFILE	WEIGHT		
	MM	IN	MM	IN	GAUGE NO/ SIZE	FRONT NO/ SIZE			KG	LB	
 	090032	89	3 1/2"	45	1 3/4"	8 x 10	9 x 10	2F	Hemispherical	4.0	8.9
	090029	102	4"	41	1 5/8"	8 x 12	6x12 / 3x10	2F	Hemispherical	4.2	9.1
 	090008	102	4"	43	1 11/16"	8 x 12	6x12 / 4x10 / 2x9	3F	Hemispherical	3.4	7.5

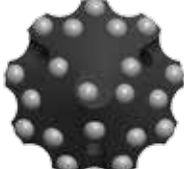

Dome Pilot Reamer Bits

PART #	DIAMETER		PILOT DIAMETER		BUTTONS		FLUSHING HOLE	CARBIDE PROFILE	WEIGHT		
	MM	IN	MM	IN	GAUGE NO/ SIZE	FRONT NO/ SIZE			KG	LB	
 	090030	102	4"	23	7/8"	9 x 12	11 x 12	2F	Hemispherical	4.0	8.9

6° Pilot Adapter

PART #	PILOT DIAMETER		PILOT LENGTH		FLUSHING HOLE	WEIGHT		THREAD	
	MM	IN	MM	IN		KG	LB		
	380003	26	1 1/32"	266	10 8/16	3F	1.6	3.5	R28

6° Reamer Buttons Bits

PART #	DIAMETER		BUTTONS		CARBIDE PROFILE	WEIGHT		
	MM	IN	GAUGE NO/ SIZE	FRONT NO/ SIZE		KG	LB	
 	070020	57	2 1/4"	8 x 9	2 x 9	Hemispherical	1.1	2.4
	070009	76	3"	8 x 10	4 x 10	Hemispherical	1.3	2.8
	070011	89	3 1/2"	8 x 10	4 x 10	Hemispherical	1.7	3.7

R32 SYSTEM REAMER TOOLS

12° Pilot Adapter



PART #	PILOT DIAMETER		FLUSHING HOLE	WEIGHT		THREAD
	MM	IN		KG	LB	
380007	40	1 9/16"	254	2.8	6.2	R32
380017	40	1 9/16"	185	1.9	4.1	R32

12° Reamer Buttons Bits



PART #	DIAMETER		BUTTONS		CARBIDE PROFILE	WEIGHT	
	MM	IN	GAUGE NO/ SIZE	FRONT NO/ SIZE		KG	LB
070030	102	4"	8 x 10	4 x 10	Hemispherical	2.4	5.3
070032	102	4"	8 x 12	6 x 12	Hemispherical	2.4	5.3
070028	127	5"	10 x 12	8 x 12	Hemispherical	3.8	8.4
070034	127	5"	10 x 12	8 x 12	Hemispherical	2.5	5.4

R32 SYSTEM COUPLINGS

Semi-Bridge Coupling



PART #	DIAMETER		LENGTH		THREAD	WEIGHT	
	MM	IN	MM	IN		KG	LB
350011	44	1 23/32"	150	6"	R32	1.1	2.4

Full Bridge Coupling





PART #	DIAMETER		LENGTH		THREAD	WEIGHT	
	MM	IN	MM	IN		KG	LB
350050	45	1 3/4"	168	6 3/5"	R32	1.3	2.8

R35 SYSTEM RODS

Tunneling / Drifting MM Rods

PART #	LENGTH		ROD CROSS SECTION	THREAD		WEIGHT		
	MM	FT/IN		BIT END	ROD END	KG	LB	
	220365	4300	14' 1 5/16"	35H	R35	R38	33.9	74.7
	220476	4915	16' 1 8/16"	35H	R35	R38	37.8	83.3
	220515	5525	18' 1 8/16"	35H	R35	R38	43.6	96.1

	220275	4300	14' 1 5/16"	35H	R35	HM38	32.9	72.5
	220306	4915	16' 1 8/16"	35H	R35	HM38	37.9	83.6
	220426	5525	18' 1 8/16"	35H	R35	HM38	42.5	93.8

	220477	4300	14' 1 5/16"	39R	R35	R38	33.5	73.8
	220480	4915	16' 1 8/16"	39R	R35	R38	38.6	85.0
	220514	6100	20' 3/16"	39R	R35	R38	48.9	107.7

	220506	4600	15' 1 2/16"	39R	R35	HM38	36.5	80.5
	220453	4915	16' 1 8/16"	39R	R35	HM38	38.7	85.3
	220455	5525	18' 1 8/16"	39R	R35	HM38	44.6	98.4
	220781	6400	21'	39R	R35	HM38	51.1	112.7

Tunneling / Drifting MF Rods

PART #	LENGTH		ROD CROSS SECTION	THREAD		WEIGHT		
	MM	FT/IN		BIT END	ROD END	KG	LB	
	300050	4300	14' 1 5/16"	39R	R35	HM38	36.1	79.6
	300042	4915	16' 1 8/16"	39R	R35	HM38	40.8	89.9

R35 SYSTEM BITS

Button Bits

PART #	DIAMETER		BUTTONS		FLUSHING HOLE	CARBIDE PROFILE	FACE PROFILE
	MM	IN	GAUGE NO/ SIZE	FRONT NO/ SIZE			
110621	41	1 5/8"	5 x 10	2 x 8	1F 2G	Hemispherical	Flat
110577	48	1 7/8"	6 x 9	3 x 8	3F 1G	Parabolic	Flat
110738	48	1 7/8"	6 x 10	3 x 8	3F 1G	Parabolic	Flat
110522	51	2"	6 x 10	3 x 9	3F 1G	Parabolic	Flat
110523	51	2"	6 x 10	3 x 9	3F 1G	Hemispherical	Flat
110654	51	2"	6 x 10	3 x 9	3F 1G	Parabolic	Flat
110739	48	1 7/8"	6 x 10	3 x 9	3F 1G	Hemispherical	Flat
110955	48	1 7/8"	6 x 10	3 x 8	3F 1G	Parabolic	Flat
110908	51	2"	6 x 10	3 x 9	3F 2G	Hemispherical	Flat
110909	51	2"	6 x 10	3 x 9	3F 2G	Parabolic	Flat
110980	57	2 1/4"	6 x 10	3 x 9	1F 1G	Hemispherical	Flat

R35 SYSTEM REAMER TOOLS

Pilot Reamer Bits

PART #	DIAMETER		PILOT DIAMETER		BUTTONS		FLUSHING HOLE	CARBIDE PROFILE	WEIGHT	
	MM	IN	MM	IN	GAUGE NO/ SIZE	FRONT NO/ SIZE			KG	LB
090018	102	4"	43	1 11/16"	8 x 12	6 x 12 / 4 x 10 / 2 x 9	3F 2R	Hemispherical	5.0	11.0



R35 SYSTEM REAMER TOOLS

Dome Pilot Reamer Bit

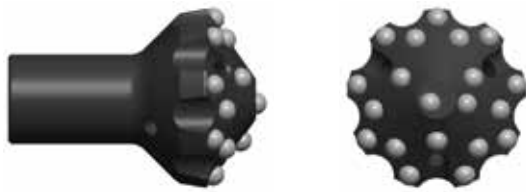

PART #	DIAMETER		BUTTONS		FLUSHING HOLE	CARBIDE PROFILE	WEIGHT	
	MM	IN	GAUGE NO/ SIZE	FRONT NO/ SIZE			KG	LB
090031	102	4"	9 x 12	11 x 12	3F 1R	Hemispherical	3.6	8.0

12° Pilot Adapter



PART #	PILOT DIAMETER		PILOT LENGTH		FLUSHING HOLE	WEIGHT		THREAD
	MM	IN	MM	IN		KG	LB	
380007	40	1 9/16"	254	10	3F	2.8	6.2	R32
380017	40	1 9/16"	185	7 5/16"	3F	1.9	4.1	R32

12° Reamer Buttons Bits



PART #	DIAMETER		BUTTONS		CARBIDE PROFILE	WEIGHT	
	MM	IN	GAUGE NO/ SIZE	FRONT NO/ SIZE		KG	LB
070030	102	4"	8 x 12	4 x 12	Hemispherical	2.4	5.3
070032	102	4"	8 x 12	6 x 12	Hemispherical	2.4	5.3
070028	127	5"	10 x 12	8 x 12	Hemispherical	3.8	8.4
070034	127	5"	10 x 12	8 x 12	Hemispherical	2.5	5.4

R35 SYSTEM COUPLING

Full Bridge Coupling



PART #	DIAMETER		LENGTH		THREAD	WEIGHT	
	MM	IN	MM	IN		KG	LB
350059	49	1 15/16"	175	6 8/9"	R35	2.0	4.4

HM35 (T35) SYSTEM RODS

Hole MM Rods

PART #	WRENCH FLATS	LENGTH		ROD CROSS SECTION	THREAD	WEIGHT	
		MM	FT/IN			KG	LB
210202	Yes	1830	6'	39R	R38	14.0	30.8

HM35 (T35) SYSTEM BITS

Button Bits

PART #	DIAMETER		BUTTONS		FLUSHING HOLE	CARBIDE PROFILE	FACE PROFILE
	MM	IN	GAUGE NO/ SIZE	FRONT NO/ SIZE			
110964	54	2 1/8"	6 x 10	3 x 9	3F 1G	Hemispherical	Flat
110965	57	2 1/4"	6 x 10	3 x 9	3F 1G	Hemispherical	Flat



R38 SYSTEM RODS

Long Hole MM Rods

PART #	WRENCH FLATS	LENGTH		ROD CROSS SECTION	THREAD	WEIGHT	
		MM	FT/IN			KG	LB
							
200087	Yes	900	2' 11 7/16"	39R	R38	7.3	16.0
200411	Yes	1220	4'	39R	R38	9.1	20.0
200506	Yes	1830	6'	39R	R38	14.0	30.8
200377	Yes	3050	10'	39R	R38	23.8	52.4
200515	No	3660	12'	39R	R38	28.7	63.2

Long Hole MF Rods



PART #	WRENCH FLATS	LENGTH		ROD CROSS SECTION	THREAD	WEIGHT	
		MM	FT/IN			KG	LB
							
210024	Yes	1220	4'	39R	R38	10.6	23.4
210134	Yes	1830	6'	39R	R38	16.0	35.3

Long Hole MF Lightning Rods

PART #	WRENCH FLATS	LENGTH		ROD CROSS SECTION	THREAD	WEIGHT	
		MM	FT/IN			KG	LB
							
210185	Yes	2440	8'	39R	R38	21.1	46.4
210187	Yes	3660	12'	39R	R38	30.5	67.2
210188	No	4270	14'	39R	R38	36.1	79.6

R38 SYSTEM BITS

Button Bits

PART #	DIAMETER		BUTTONS		FLUSHING HOLE	CARBIDE PROFILE	FACE PROFILE
	MM	IN	GAUGE NO./ SIZE	FRONT NO./ SIZE			
							
110129	64	2 1/2"	6 x 12	3 x 10	1F 2G	Hemispherical	Flat
							
110291	102	4"	8 x 14	7 x 12	2F 2G	Hemispherical	Flat

R38 SYSTEM BITS

Straightrac Button Bits



PART #	DIAMETER		BUTTONS		FLUSHING HOLE	CARBIDE PROFILE	FACE PROFILE
	MM	IN	GAUGE NO/ SIZE	FRONT NO/ SIZE			
140190	64	2 1/2"	8 x 9	5 x 9	4F 1G	Hemispherical	Recess
140191	76	3"	8 x 11	5 x 11	4F 1G	Hemispherical	Recess
140193	61	2 3/8"	8 x 9	5 x 9	4F 1G	Hemispherical	Recess
140205	66	2 5/8"	8 x 9	5 x 9	4F 1G	Parabolic	Recess

R38 SYSTEM REAMER TOOLS

Pilot Reamer Bits



PART #	DIAMETER		BUTTONS		FLUSHING HOLE	CARBIDE PROFILE	WEIGHT	
	MM	IN	GAUGE NO/ SIZE	FRONT NO/ SIZE			KG	LB
990067	127	5"	8 x 14	6 x 14 / 3 x 10	2F	Hemispherical	5.8	12.9

R38 SYSTEM COUPLING

Semi-Bridge Couplings



PART #	DIAMETER		LENGTH		THREAD	WEIGHT	
	MM	IN	MM	IN		KG	LB
350029	55	2 3/16"	170	6 2/3"	R38	1.8	4.0

Full Bridge Couplings



PART #	DIAMETER		LENGTH		THREAD	WEIGHT	
	MM	IN	MM	IN		KG	LB
350041	55	2 3/16"	175	6 8/9"	R38	2.0	4.4

HM38 (T38) SYSTEM RODS

Long Hole MM Rods

PART #	WRENCH FLATS	LENGTH		ROD CROSS SECTION	THREAD	WEIGHT	
		MM	FT/IN			KG	LB
							
200416	No	250	9 13/16"	39R	HM38	1.7	3.8
200493	Yes	1830	6'	39R	HM38	14.0	30.8
200447	Yes	3050	10'	39R	HM38	23.4	51.5
200485	Yes	3050	10'	39R	HM38	22.5	49.5
200375	No	3660	12'	39R	HM38	27.4	60.3
200383	Yes	4000	13' 1 8/16"	39R	HM38	30.1	66.4
200524	No	4880	16' 2/16"	39R	HM38	38.6	85.1
200509	No	5490	18' 2/16"	39R	HM38	43.7	96.4

Long Hole MM Induction Hardened Rods

PART #	WRENCH FLATS	LENGTH		ROD CROSS SECTION	THREAD	WEIGHT	
		MM	FT/IN			KG	LB
							
200316	Yes	3050	10'	39R	HM38	24.2	53.4
200365	No	3050	10'	39R	HM38	24.2	53.4
200366	No	3660	12'	39R	HM38	27.1	59.8
200367	No	4270	14'	39R	HM38	31.6	69.7
200417	No	4880	16' 2/16"	39R	HM38	36.1	79.7

Long Hole MF Rods



PART #	WRENCH FLATS	LENGTH		ROD CROSS SECTION	THREAD	WEIGHT	
		MM	FT/IN			KG	LB
							
210064	No	910	3'	39R	HM38	8.4	18.5
210029	Yes	1220	4'	39R	HM38	11.0	24.3
210044	No	1220	4'	39R	HM38	11.2	24.6
210093	Yes	1220	4'	39R	HM38	10.5	23.0
210030	No	1520	5'	39R	HM38	13.4	29.5
210031	No	1830	6'	39R	HM38	15.8	34.9
210106	Yes	1830	6'	39R	HM38	15.9	35.1
210045	No	2440	8'	39R	HM38	21.1	46.4
210175	No	2950	9' 8 2/16"	39R	HM38	24.9	54.8
210032	No	3050	10'	39R	HM38	26.3	58.1
210110	Yes	3050	10'	39R	HM38	25.7	56.7
210033	No	3660	12'	39R	HM38	30.4	67.0
210046	No	3660	12'	39R	HM38	31.6	69.6
210112	No	4270	14'	39R	HM38	36.1	79.6

HM38 (T38) SYSTEM RODS

Long Hole MF Lightning Rods

PART #	WRENCH FLATS	LENGTH		ROD CROSS SECTION	THREAD	WEIGHT		
		MM	FT/IN			KG	LB	
								
210189	No	2440	8'	39R	HM38	21.1	46.4	
210190	No	3050	10'	39R	HM38	26.3	58.1	
210191	Yes	3660	12'	39R	HM38	31.6	69.6	
210192	Yes	4270	14'	39R	HM38	36.1	79.6	

Long Hole MF Retrac Rods

PART #	WRENCH FLATS	LENGTH		ROD CROSS SECTION	THREAD	WEIGHT		
		MM	FT/IN			KG	LB	
								
210072	No	1220	4'	38H	HM38	11.9	26.2	
210122	No	1520	5'	38H	HM38	13.3	29.3	
210201	No	1830	6'	38H	HM38	14.7	32.4	
								
210230	No	1220	4'	39R	HM38	9.7	21.3	
210231	No	1520	5'	39R	HM38	9.7	21.3	

Long Hole MF / 61mm / Spiral Guides Rods

PART #	WRENCH FLATS	LENGTH		ROD CROSS SECTION	THREAD	WEIGHT		
		MM	FT/IN			KG	LB	
								
280007	No	1220	4'	39R	HM38	12.2	27.0	
280009	No	1830	6'	39R	HM38	17.2	37.9	

Long Hole MF / 64mm / Guides Rods

PART #	WRENCH FLATS	LENGTH		ROD CROSS SECTION	THREAD	WEIGHT		
		MM	FT/IN			KG	LB	
								
280032	No	1220	4'	38H	HM38	11.8	26.0	

HM38 (T38) SYSTEM RODS

Long Hole MF Guide Tubes

PART #	WRENCH FLATS	LENGTH		ROD CROSS SECTION	THREAD	WEIGHT	
		MM	FT/IN			KG	LB
270012	Yes	1220	4'	55T	HM38	16.3	35.9
270082	Yes	1525	5'	55T	HM38	15.6	34.4
270013	Yes	1830	6'	55T	HM38	18.4	40.5



HM38 (T38) SYSTEM BITS

Button Bits

PART #	DIAMETER		BUTTONS		FLUSHING HOLE	CARBIDE PROFILE	FACE PROFILE
	MM	IN	GAUGE NO/ SIZE	FRONT NO/ SIZE			
110022	64	2 1/2"	6 x 12	3 x 10	1F 2G	Hemispherical	Flat
110384	64	2 1/2"	6 x 12	3 x 10	1F 2G	Parabolic	Flat
110674	64	2 1/2"	6 x 12	3 x 11	3F	Hemispherical	Flat
110549	63	2 8/16"	8 x 10	4 x 9	3G	Parabolic	Flat
110912	54	2 1/8"	6 x 11	3 x 10	3F 1G	Parabolic	Flat
110809	64	2 1/2"	6 x 11	3 x 10	3F 1G	Parabolic	Flat
110363	64	2 1/2"	6 x 11	3 x 10	3F 1G	Hemispherical	Flat
110718	64	2 1/2"	6 x 11	4 x 10	3F	Hemispherical	Recess
110719	64	2 1/2"	6 x 11	4 x 10	3F	Parabolic	Recess
110656	70	2 3/4"	6 x 13	3 x 11 / 1 x 10	3F	Hemispherical	Recess
110720	76	3"	6 x 11	4 x 11	3F	Hemispherical	Recess
110203	76	3"	8 x 11	4 x 11	2F 1G	Hemispherical	Flat
110830	76	3"	8 x 12	4 x 11	2F 1G	Hemispherical	Flat
110712	76	3"	8 x 12	4 x 12	2F 1G	Hemispherical	Flat
110793	76	3"	8 x 11	4 x 11	2F 1G	Parabolic	Flat
110849	76	3"	8 x 11	4 x 11	2F 1G	Parabolic	Flat
110805	80	3 1/8"	8 x 11	4 x 11	2F 1G	Hemispherical	Flat

HM38 (T38) SYSTEM BITS

Button Bits

PART #	DIAMETER		BUTTONS		FLUSHING HOLE	CARBIDE PROFILE	FACE PROFILE
	MM	IN	GAUGE NO/ SIZE	FRONT NO/ SIZE			
110814	89	3 1/2"	8 x 12	5 x 11	2F 2G	Hemispherical	Flat
110741	102	4"	8 x 14	5 x 12	2F	Hemispherical	Recess
110288	102	4"	8 x 14	7 x 12	2F 2G	Hemispherical	Flat
110634	102	4"	8 x 14	7 x 12	2F 2G	Parabolic	Flat

Blade Bits

PART #	DIAMETER		GAUGE CARBIDE	FLUSHING HOLE
	MM	IN		
120058	64	2 1/2"	26 x 12	1F 4G
120067	76	3"	26 x 16	1F 4G
120349	64	2 1/2"	26 x 12	1F 2G
120348	76	3"	26 x 16	1F 2G

Retrac Button Bits

PART #	DIAMETER		BUTTONS		FLUSHING HOLE	CARBIDE PROFILE	FACE PROFILE
	MM	IN	GAUGE NO/ SIZE	FRONT NO/ SIZE			
130049	64	2 1/2"	5 x 11	4 x 10	2F	Hemispherical	Recess
130059	64	2 1/2"	5 x 11	4 x 10	2F	Parabolic	Recess
130057	64	2 1/2"	6 x 13	3 x 10	3F 1RF	Hemispherical	Flat

HM38 (T38) SYSTEM BITS

Retrac Button Bits

PART #	DIAMETER		BUTTONS		FLUSHING HOLE	CARBIDE PROFILE	FACE PROFILE
	MM	IN	GAUGE NO/ SIZE	FRONT NO/ SIZE			
130011	76	3"	6 x 12	3 x 12	3F	Hemispherical	Flat
130079	76	3"	6 x 13	3 x 11 / 1 x 10	3F 3RF	Hemispherical	Recess
130074	89	3 1/2"	6 x 12	5 x 12	3F	Hemispherical	Recess

Straightrac Button Bits

PART #	DIAMETER		BUTTONS		FLUSHING HOLE	CARBIDE PROFILE	FACE PROFILE
	MM	IN	GAUGE NO/ SIZE	FRONT NO/ SIZE			
140052	64	2 1/2"	6 x 10	3 x 10 / 1 x 9	3F 1G	Hemispherical	Recess
140060	64	2 1/2"	6 x 10	3 x 10 / 1 x 9	3F 1G	Parabolic	Recess
140031	64	2 1/2"	6 x 11	3 x 10	3F 1G	Hemispherical	Flat
140035	76	3"	6 x 11	3 x 11 / 2 x 10	3F 1G	Hemispherical	Recess
140097	64	2 1/2"	8 x 9	5 x 9	4F 1G	Hemispherical	Recess
140115	64	2 1/2"	8 x 9	5 x 9	4F 1G	Parabolic	Recess
140136	76	3"	8 x 11	5 x 11	4F 1G	Hemispherical	Recess
140077	76	3"	8 x 11	5 x 11	4F 1G	Parabolic	Recess

HM38 (T38) SYSTEM REAMER TOOLS

Pilot Reamer Bits

PART #	DIAMETER		PILOT DIAMETER		BUTTONS		FLUSHING HOLE	CARBIDE PROFILE	WEIGHT	
	MM	IN	MM	IN	GAUGE NO/ SIZE	FRONT NO/ SIZE			KG	LB
090028	89	3 1/2"	48	1 7/8"	8 x 10	9 x 10	2F	Hemispherical	3.7	8.1
090019	102	4"	48	1 7/8"	8 x 12	6x12 / 3x10	2F	Hemispherical	5.3	11.6
090026	115	4 1/2"	48	1 7/8"	8 x 12	6x12 / 3x10	2F	Hemispherical	5.8	12.7
090021	127	5"	48	1 7/8"	8 x 14	6x14 / 3x10	2F	Hemispherical	5.8	12.9
090035	152	6"	76	3"	9 x 16	6x16 / 6x12	3F	Hemispherical	15.0	33.1
090024	152	6"	89	3 1/2"	9 x 16	6x16 / 6x12	3F	Hemispherical	15.0	33.1

HM38 (T38) SYSTEM COUPLING

Semi-Bridge Couplings

PART #	DIAMETER		LENGTH		THREAD	WEIGHT	
	MM	IN	MM	IN		KG	LB
350002	55	2 3/16"	191	7 1/2"	HM38	1.8	4.0

Full Bridge Couplings

PART #	DIAMETER		LENGTH		THREAD	WEIGHT	
	MM	IN	MM	IN		KG	LB
350045	55	2 3/16"	187	7 3/8"	HM38	2.1	4.6

HM45 (T45) SYSTEM RODS

Long Hole MM Rods

PART #	WRENCH FLATS	LENGTH		ROD CROSS SECTION	THREAD	WEIGHT		
		MM	FT/IN			KG	LB	
								
200379	No	2000	6' 6 12/16"	46R	HM45	21.2	46.7	
200320	Yes	3050	10'	46R	HM45	32.7	72.0	
200468	No	3050	10'	46R	HM45	32.7	72.0	
200486	No	3660	12'	46R	HM45	39.7	87.5	
200455	No	5480	17' 11 12/16"	46R	HM45	60.0	132.3	

Long Hole MM Induction Hardened Rods

PART #	WRENCH FLATS	LENGTH		ROD CROSS SECTION	THREAD	WEIGHT		
		MM	FT/IN			KG	LB	
								
200463	No	610	2'	46R	HM45	6.1	13.5	
200438	No	1220	4'	46R	HM45	12.9	28.4	
200427	No	1830	6'	46R	HM45	19.8	43.6	
200361	No	3050	10'	46R	HM45	33.1	72.9	
200362	No	3660	12'	46R	HM45	39.7	87.5	
200386	No	4270	14'	46R	HM45	46.3	102.1	
200418	No	4730	15' 6 4/16"	46R	HM45	51.3	113.0	
200464	No	4880	16' 2/16"	46R	HM45	53.5	117.9	
200397	No	6100	20' 3/16"	46R	HM45	68.1	150.0	

Long Hole MF Rods

PART #	WRENCH FLATS	LENGTH		ROD CROSS SECTION	THREAD	WEIGHT		
		MM	FT/IN			KG	LB	
								
210080	No	910	3'	46R	HM45	11.8	26.0	
210048	No	1220	4'	46R	HM45	15.0	33.0	
210035	No	1520	5'	46R	HM45	18.5	40.8	
210126	No	1830	6'	46R	HM45	22.5	49.6	
210091	No	2440	8'	46R	HM45	28.0	61.7	
210037	No	3050	10'	46R	HM45	37.5	82.6	
210118	Yes	3050	10'	46R	HM45	34.7	76.6	
210038	No	3660	12'	46R	HM45	42.5	93.6	
210108	Yes	3660	12'	46R	HM45	42.5	93.6	
210177	No	3660	12'	46R	HM45	42.5	93.6	
210213	No	3660	12'	46R	HM45	41.8	92.1	
210082	No	4270	14'	46R	HM45	49.1	108.3	

HM45 (T45) SYSTEM RODS

Long Hole MF Lightning Rods

PART #	WRENCH FLATS	LENGTH		ROD CROSS SECTION	THREAD	WEIGHT		
		MM	FT/IN			KG	LB	
								
210193	Yes	3050	10'	46R	HM45	35.3	77.8	
210194	No	3660	12'	46R	HM45	42.1	92.8	
210195	No	4270	14'	46R	HM45	48.9	107.8	
210226	No	5490	18' 2/16"	46R	HM45	62.5	137.7	

Long Hole MF Retrac Rods

PART #	WRENCH FLATS	LENGTH		ROD CROSS SECTION	THREAD	WEIGHT		
		MM	FT/IN			KG	LB	
								
210205	No	1830	6'	46R	HM45	22.1	48.8	

Long Hole MF / 76mm / Guides Rods

PART #	WRENCH FLATS	LENGTH		ROD CROSS SECTION	THREAD	WEIGHT		
		MM	FT/IN			KG	LB	
								
280033	No	1220	4'	46R	HM45	17.3	38.2	

Long Hole MF Guide Tubes

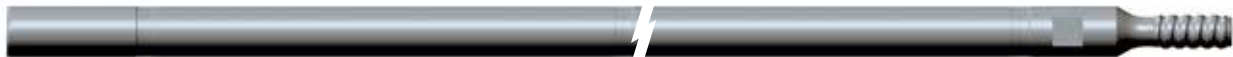
PART #	WRENCH FLATS	LENGTH		ROD CROSS SECTION	THREAD	WEIGHT		
		MM	FT/IN			KG	LB	
								
270022	Yes	1220	4'	66T	HM45	20.9	46.0	
270081	Yes	1525	5'	66T	HM45	28.6	63.0	
270052	Yes	1830	6'	66T	HM45	33.8	74.6	

Long Hole MF Drill Tubes

PART #	WRENCH FLATS	LENGTH		ROD CROSS SECTION	THREAD	WEIGHT		
		MM	FT/IN			KG	LB	
								
270069	Yes	1220	4'	66T	HM45	24.5	53.9	
270035	Yes	1525	5'	66T	HM45	29.7	65.6	
270033	Yes	1830	6'	66T	HM45	34.6	76.3	

HM45 (T45) SYSTEM BITS

Button Bits

PART #	DIAMETER		BUTTONS		FLUSHING HOLE	CARBIDE PROFILE	FACE PROFILE
	MM	IN	GAUGE NO/ SIZE	FRONT NO/ SIZE			
110948	76	3"	6 x 14	4 x 12	2F	Ballistic	Flat
110412	76	3"	6 x 12	4 x 10	3F 1G	Hemispherical	Flat
110790	76	3"	6 x 12	4 x 11	3F 1G	Hemispherical	Flat
110833	85	3 3/8"	6 x 13	4 x 13	2F 2G	Ballistic	Flat
110834	85	3 3/8"	6 x 13	4 x 13	2F 2G	Parabolic	Flat
110766	89	3 1/2"	8 x 12	5 x 11	2F 2G	Hemispherical	Flat
110137	89	3 1/2"	6 x 14	5 x 12	1F 2G	Hemispherical	Flat
110722	76	3"	6 x 11	4 x 11	3F	Hemispherical	Recess
110723	76	3"	6 x 11	4 x 11	3F	Parabolic	Recess
110895	76	3"	6 x 12	4 X 11	3F	Parabolic	Recess
110509	102	4"	9 x 12	7 x 12	3F	Hemispherical	Flat
110216	76	3"	6 x 11	3 x 11 / 2 x 10	3F	Hemispherical	Recess
110661	89	3 1/2"	6 x 12	5 x 12	3F	Hemispherical	Recess
110204	76	3"	8 X 11	4 X 11	2F 1G	Hemispherical	Flat
110713	76	3"	8 X 12	4 X 12	2F 1G	Hemispherical	Flat

HM45 (T45) SYSTEM BITS

Button Bits



PART #	DIAMETER		BUTTONS		FLUSHING HOLE	CARBIDE PROFILE	FACE PROFILE
	MM	IN	GAUGE NO/ SIZE	FRONT NO/ SIZE			
110853	89	3 1/2"	8 x 11	6 x 11	4F 1G	Parabolic	Recess
							
110942	76	3"	8 X 12	4 X 12	2F 2G	Parabolic	Flat
110716	89	3 1/2"	8 X 14	4 X 14	2F 2G	Hemispherical	Flat
							
110724	102	4"	8 x 14	5 x 12	2F	Hemispherical	Recess
110725	102	4"	8 x 14	5 x 12	2F	Parabolic	Recess
							
110842	89	3 1/2"	8 x 12	6 x 12	2F	Parabolic	Flat
							
110924	115	4 1/2"	8 x 14	6 x 14	4F	Hemispherical	Recess
							

Blade Bits

PART #	DIAMETER		GAUGE CARBIDE	FLUSHING HOLE
	MM	IN		
120307	76	3"	26 x 16	1F 4G
				

HM45 (T45) SYSTEM BITS

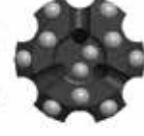
Retrac Button Bits

PART #	DIAMETER		BUTTONS		FLUSHING HOLE	CARBIDE PROFILE	FACE PROFILE	
	MM	IN	GAUGE NO/ SIZE	FRONT NO/ SIZE				
 	130058	76	3"	6 x 13	3 x 11 / 1 x 10	3F	Hemispherical	Recess
	130105	76	3"	6 x 11	4 x 11	3F	Parabolic	Recess
 	130012	76	3"	6 x 13	3 x 11 / 1 x 10	3F 3RF	Hemispherical	Recess
 	130080	89	3 1/2"	6 x 12	5 x 12	3F	Hemispherical	Recess
	130136	89	3 1/2"	6 x 12	5 x 12	3F	Parabolic	Recess
 	130081	102	4"	8 x 14	5 x 12	3F	Hemispherical	Recess
 	130071	89	3 1/2"	9 x 11	6 X 11	3F	Parabolic	Flat

Straightrac Button Bits

PART #	DIAMETER		BUTTONS		FLUSHING HOLE	CARBIDE PROFILE	FACE PROFILE	
	MM	IN	GAUGE NO/ SIZE	FRONT NO/ SIZE				
 	140039	76	3"	6 x 11	3 x 11 / 2 x 10	3F	Hemispherical	Recess
 	140203	76	3"	6 x 11	3 x 11 / 2 x 10	3F	Hemispherical	Recess







HM45 (T45) SYSTEM

Straightrac Button Bits

PART #	DIAMETER		BUTTONS		FLUSHING HOLE	CARBIDE PROFILE	FACE PROFILE
	MM	IN	GAUGE NO/ SIZE	FRONT NO/ SIZE			
140221	76	3"	6 x 11	3 x 11 / 2 x 10	3F 2RF	Hemispherical	Recess
140132	70	2 3/4"	8 x 10	5 x 10	4F	Hemispherical	Recess
140160	70	2 3/4"	8 x 10	5 x 10	4F	Parabolic	Recess
140114	76	3"	8 x 11	5 x 11	4F 1G	Parabolic	Recess
140109	76	3"	8 x 11	5 x 11	4F 1G	Hemispherical	Recess
140071	89	3 1/2"	8 x 11	6 x 11	4F 1G	Hemispherical	Recess
140072	89	3 1/2"	8 x 11	6 x 11	4F 1G	Parabolic	Recess
140125	102	4"	8 x 14	6 x 12	4F 1G	Hemispherical	Recess
140163	102	4"	8 x 14	6 x 12	4F 1G	Parabolic	Recess
140169	89	3 1/2"	8 x 14	6 x 12	2F	Parabolic	Flat
140178	89	3 1/2"	9 x 11	6 x 11	3F 1G	Hemispherical	Flat
140218	89	3 1/2"	9 x 12	6 x 11 / 2 x 10	3F 2RF	Hemispherical / Parabolic	Recess
140176	76	3"	9 x 10	8 x 10	3F 1RF	Parabolic	Recess

HM45 (T45) SYSTEM REAMER TOOLS

Pilot Reamer Bits

PART #	DIAMETER		PILOT DIAMETER		BUTTONS		FLUSHING HOLE	CARBIDE PROFILE	WEIGHT		
	MM	IN	MM	IN	GAUGE NO/ SIZE	FRONT NO/ SIZE			KG	LB	
	090027	115	4 1/2	48	1 7/8"	8 x 12	6 x 12 / 3x10	2F	Hemispherical	5.5	12.2
	090025	127	5	48	1 7/8"	8 x 14	6 x 14 / 3x10	2F	Hemispherical	5.7	12.5
	090034	152	6	76	3"	9 x 16	6x16 / 6x12	3F	Hemispherical	14.7	32.5
	090023	152	6	89	3 1/2"	9 x 16	7x16 / 6x12	3F	Hemispherical	14.7	32.5
	990059	152	6	70	2 3/4	9 x 16	6x16 / 5x12	3F	Hemispherical	14.7	32.5
											

HM45 (T45) SYSTEM COUPLING

Semi-Bridge Couplings

PART #	DIAMETER		LENGTH		THREAD	WEIGHT		
	MM	IN	MM	IN		KG	LB	
	350012	66	2 5/8"	210	8 1/4"	HM45	3.3	7.3
	350034	63	2 1/2"	210	8 1/4"	HM45	2.7	6.0

Full Bridge Couplings

PART #	DIAMETER		LENGTH		THREAD	WEIGHT		
	MM	IN	MM	IN		KG	LB	
	350046	66	2 5/8"	213	8 2/5"	HM45	3.4	7.6

HM51 (T51) SYSTEM RODS

Long Hole MM Rods

PART #	WRENCH FLATS	LENGTH		ROD CROSS SECTION	THREAD	WEIGHT		
		MM	FT/IN			KG	LB	
								
200398	No	910	3'	52R	HM51	13.7	30.3	
200487	No	3660	12'	52R	HM51	49.8	109.8	

Long Hole MM Induction Hardened Rods

PART #	WRENCH FLATS	LENGTH		ROD CROSS SECTION	THREAD	WEIGHT		
		MM	FT/IN			KG	LB	
								
203008	No	610	2'	52R	HM51	8.4	18.4	
200363	No	3660	12'	52R	HM51	49.8	109.8	
200422	No	4270	14'	52R	HM51	58.3	128.5	
200364	No	6100	20' 3/16"	52R	HM51	83.5	184.1	
200404	No	7320	24' 3/16"	52R	HM51	104.6	230.7	

Long Hole MF Rods

PART #	WRENCH FLATS	LENGTH		ROD CROSS SECTION	THREAD	WEIGHT		
		MM	FT/IN			KG	LB	
								
210040	No	1525	5'	52R	HM51	24.0	52.9	
210154	No	1830	6'	52R	HM51	26.7	58.9	
210042	No	3660	12'	52R	HM51	52.6	116.1	
210083	No	4270	14'	52R	HM51	61.1	134.7	
210043	No	6100	20' 3/16"	52R	HM51	86.7	191.1	

Long Hole MF Lightning Rods

PART #	WRENCH FLATS	LENGTH		ROD CROSS SECTION	THREAD	WEIGHT		
		MM	FT/IN			KG	LB	
								
210218	Yes	3000	9' 10 2/16"	52R	HM51	44.9	98.9	
210196	Yes	3660	12'	52R	HM51	52.6	115.9	
210197	Yes	4270	14'	52R	HM51	61.1	134.7	
210227	No	5490	18' 2/16"	52R	HM51	77.8	171.4	
210222	No	6100	20' 3/16"	52R	HM51	86.7	191.1	

HM51 (T51) SYSTEM RODS

Long Hole MF Guide Tubes

PART #	WRENCH FLATS	LENGTH		ROD CROSS SECTION	THREAD	WEIGHT	
		MM	FT/IN			KG	LB
270018	Yes	1830	6'	76T	HM51	43.0	94.9
270019	Yes	3660	12'	76T	HM51	82.0	180.8

Long Hole FF Guide Tubes

PART #	WRENCH FLATS	LENGTH		ROD CROSS SECTION	THREAD	WEIGHT	
		MM	FT/IN			KG	LB
270085	Yes	3660	12'	76T	HM51	84.3	185.8

HM51 (T51) SYSTEM BITS

Button Bits

PART #	DIAMETER		BUTTONS		FLUSHING HOLE	CARBIDE PROFILE	FACE PROFILE
	MM	IN	GAUGE NO/ SIZE	FRONT NO/ SIZE			
110663	89	3 1/2"	6 X 12	5 X 12	3F	Hemispherical	Recess
110662	89	3 1/2"	6 X 12	5 X 12	3F	Parabolic	Recess
110219	89	3 1/2"	6 X 14	5 X 12	1F 2G	Hemispherical	Flat
110438	89	3 1/2"	6 X 14	5 X 12	1F 2G	Parabolic	Flat
110703	102	4"	8 X 14	5 X 12	2F	Hemispherical	Recess
110726	102	4"	8 X 14	5 X 12	2F	Parabolic	Recess
110701	115	4 1/2"	8 X 14	6 X 14	4F	Hemispherical	Recess
110699	127	5"	8 X 14	7 X 14	4F	Hemispherical	Recess
110923	140	5 1/2"	8 X 16	7 X 16	4F	Hemispherical	Recess

HM51 (T51) SYSTEM BITS

Button Bits

PART #	DIAMETER		BUTTONS		FLUSHING HOLE	CARBIDE PROFILE	FACE PROFILE
	MM	IN	GAUGE NO/ SIZE	FRONT NO/ SIZE			
110360	89	3 1/2"	8 x 12	6 x 12	2F 1G	Hemispherical	Flat
110437	102	4"	8 x 14	7 x 12	2F 2G	Parabolic	Flat
110141	102	4"	8 x 14	7 x 12	2F 2G	Hemispherical	Flat
110950	115	4 1/2"	8 x 14	8 x 14	4F 1G	Hemispherical	Recess
110737	89	3 1/2"	9 X 12	8 X 11	3F	Parabolic	Recess
110511	115	4 1/2"	9 x 13	8 x 13	3F	Parabolic	Flat
110510	115	4 1/2"	9 x 13	8 x 13	3F	Hemispherical	Flat

Retrac Button Bits

PART #	DIAMETER		BUTTONS		FLUSHING HOLE	CARBIDE PROFILE	FACE PROFILE
	MM	IN	GAUGE NO/ SIZE	FRONT NO/ SIZE			
130101	89	3 1/2"	6 X 12	5 X 12	3F	Hemispherical	Recess
130107	89	3 1/2"	6 X 12	5 X 12	3F	Parabolic	Recess
130082	102	4"	8 X 14	5 X 12	2F	Hemispherical	Recess
130083	115	4 1/2"	8 X 14	6 X 14	4F	Hemispherical	Recess

HM51 (T51) SYSTEM BITS

Retrac Button Bits

PART #	DIAMETER		BUTTONS		FLUSHING HOLE	CARBIDE PROFILE	FACE PROFILE
	MM	IN	GAUGE NO/ SIZE	FRONT NO/ SIZE			
130008	102	4"	8 x 14	7 x 12	2F	Hemispherical	Flat
130100	102	4"	8 x 14	7 x 12	2F	Parabolic	Flat
130084	127	5"	8 X 14	7 X 14	4F	Hemispherical	Recess
130055	115	4 1/2"	9 x 13	9 x 13	3F	Hemispherical	Recess
130054	127	5"	9 x 14	9 x 14	3F	Hemispherical	Recess

Straightrac Button Bits

PART #	DIAMETER		BUTTONS		FLUSHING HOLE	CARBIDE PROFILE	FACE PROFILE
	MM	IN	GAUGE NO/ SIZE	FRONT NO/ SIZE			
140212	83	3 1/4"	8 x 11	6 x 11	4F 1G	Parabolic	Recess
140095	89	3 1/2"	8 x 11	6 x 11	4F 1G	Parabolic	Recess
140045	102	4"	6 x 16	3 x 14 / 2 x 12	3F	Hemispherical	Recess
140098	102	4"	6 x 16	3 x 14 / 2 x 12	3F	Parabolic	Recess
140042	115	4 1/2"	9 x 14	6 x 14	3F	Hemispherical	Flat

HM51 (T51) SYSTEM COUPLING

Semi-Bridge Couplings



PART #	DIAMETER		LENGTH		THREAD	WEIGHT	
	MM	IN	MM	IN		KG	LB
350013	72	2 13/16"	235	9 1/4"	HM51	4.9	10.8
350014	76	3"	235	9 1/4"	HM51	5.0	11.0

Full Bridge Couplings



PART #	DIAMETER		LENGTH		THREAD	WEIGHT	
	MM	IN	MM	IN		KG	LB
350048	76	3"	251	9 7/8"	HM51	5.6	12.3

BE58 SYSTEM RODS

Long Hole MF Rods

PART #	WRENCH FLATS	LENGTH		ROD CROSS SECTION	THREAD	WEIGHT	
		MM	FT/IN			KG	LB
210089	No	4270	14'	60R	BE58	83.3	183.6

Long Hole MF Drill Tubes

PART #	WRENCH FLATS	LENGTH		ROD CROSS SECTION	THREAD	WEIGHT	
		MM	FT/IN			KG	LB
270051	No	1830	6'	76T	BE58	42.4	93.6

BE58 SYSTEM BITS

Button Bits

PART #	DIAMETER		BUTTONS		FLUSHING HOLE	CARBIDE PROFILE	FACE PROFILE
	MM	IN	GAUGE NO/ SIZE	FRONT NO/ SIZE			
110270	102	4"	8 x 14	7 x 12	2F 2G	Hemispherical	Flat
110937	102	4"	8 x 14	6 x 14	2F	Hemispherical	Flat
110272	115	4 1/2"	8 x 14	8 x 12	2F 2G	Hemispherical	Flat
110727	89	3 1/2"	9 x 12	6 x 12	3F	Hemispherical	Flat

BE58 SYSTEM BITS

Retrac Button Bits

PART #	DIAMETER		BUTTONS		FLUSHING HOLE	CARBIDE PROFILE	FACE PROFILE
	MM	IN	GAUGE NO/ SIZE	FRONT NO/ SIZE			
130102	102	4"	9 x 12	11 x 12	2F	Parabolic	Flat
130088	102	4"	9 x 12	7 x 12	3F	Parabolic	Flat

Straightrac Button Bits

PART #	DIAMETER		BUTTONS		FLUSHING HOLE	CARBIDE PROFILE	FACE PROFILE
	MM	IN	GAUGE NO/ SIZE	FRONT NO/ SIZE			
140189	89	3 1/2"	8 x 12	4 x 12 / 1 x 11	4F	Parabolic	Recess
140187	89	3 1/2"	9 x 12	8 x 11	3F	Hemispherical	Recess

BE58 SYSTEM BITS

Pilot Reamer Bits

PART #	DIAMETER		PILOT DIAMETER		BUTTONS		FLUSHING HOLE	CARBIDE PROFILE	WEIGHT	
	MM	IN	MM	IN	GAUGE NO/ SIZE	FRONT NO/ SIZE			KG	LB
990063	127	5"	76	3"	9 x 14	6x14 / 6x12	3F	Hemispherical	8.5	18.7
990058	152	6"	80	3 1/8"	9 x 16	6x16 / 6x12	3F	Hemispherical	11.8	25.9
990060	203	8"	135	5 5/16"	18 x 14	13 x 14	3F	Hemispherical	22.7	50.1

EL60 SYSTEM RODS

Long Hole MM Induction Hardened Rods

PART #	WRENCH FLATS	LENGTH		ROD CROSS SECTION	THREAD	WEIGHT		
		MM	FT/IN			KG	LB	
								
203011	No	910	3'	60R	EL60	16.6	36.5	
200529	No	3660	12'	60R	EL60	70.2	154.7	
200530	No	4270	14'	60R	EL60	81.3	179.2	
200543	No	6100	20' 3/16"	60R	EL60	116.3	256.3	

Long Hole MF Rods

PART #	WRENCH FLATS	LENGTH		ROD CROSS SECTION	THREAD	WEIGHT		
		MM	FT/IN			KG	LB	
								
210164	No	4270	14'	60R	EL60	83.7	184.6	
210180	No	6100	20' 3/16"	60R	EL60	113.4	250.0	

Long Hole MF Lightning Rods











PART #	WRENCH FLATS	LENGTH		ROD CROSS SECTION	THREAD	WEIGHT		
		MM	FT/IN			KG	LB	
								
210214	No	1220	4'	60R	EL60	25.8	56.9	
210219	No	1800	5' 10 14/16"	60R	EL60	36.4	80.2	
210198	No	3660	12'	60R	EL60	72.2	159.2	
210199	No	4270	14'	60R	EL60	83.7	184.6	
210221	No	6100	20' 3/16"	60R	EL60	113.4	250.0	

Long Hole MF Lightning Drill Tubes

PART #	WRENCH FLATS	LENGTH		ROD CROSS SECTION	THREAD	WEIGHT		
		MM	FT/IN			KG	LB	
								
270086	No	4270	14'	87T	EL60	106.4	234.5	

EL60 SYSTEM BITS

Button Bits

PART #	DIAMETER		BUTTONS		FLUSHING HOLE	CARBIDE PROFILE	FACE PROFILE	
	MM	IN	GAUGE NO/ SIZE	FRONT NO/ SIZE				
 	110900	92	3 5/8"	8 x 13	5 x 12	2F	Hemispherical	Recess
	110887	102	4"	8 x 14	5 x 12	2F	Hemispherical	Recess
 	110993	102	4"	8 x 14	6 x 12	2F	Hemispherical	Flat
 	110888	115	4 1/2"	8 x 14	6 x 14	4F	Hemispherical	Recess
 	110994	115	4 1/2"	8 x 14	6 x 14	4F	Hemispherical	Flat
 	110889	127	5"	8 x 14	7 x 14	4F	Hemispherical	Recess
	110918	127	5"	8 x 16	7 x 14	4F	Hemispherical	Recess
	110890	140	5 1/2"	8 x 16	7 x 16	4F	Hemispherical	Recess

Retrac Button Bits

PART #	DIAMETER		BUTTONS		FLUSHING HOLE	CARBIDE PROFILE	FACE PROFILE	
	MM	IN	GAUGE NO/ SIZE	FRONT NO/ SIZE				
 	130114	102	4"	8 x 14	5 x 12	2F	Hemispherical	Recess
 	130115	115	4 1/2"	8 x 14	6 x 14	4F	Hemispherical	Recess
 	130113	127	5"	8 x 14	7 x 14	4F	Hemispherical	Recess
	130120	127	5"	8 x 16	7 x 14	4F	Hemispherical	Recess
	130116	140	5 1/2"	8 x 16	7 x 16	4F	Hemispherical	Recess

EL60 SYSTEM BITS

Retrac Button Bits



PART #	DIAMETER		BUTTONS		FLUSHING HOLE	CARBIDE PROFILE	FACE PROFILE
	MM	IN	GAUGE NO/ SIZE	FRONT NO/ SIZE			
130137	152	6"	9 x 16	6 x 16 / 4 x 14	3F	Hemispherical	Recess

EL60 SYSTEM COUPLING

Semi-Bridge Coupling



PART #	DIAMETER		LENGTH		THREAD	WEIGHT	
	MM	IN	MM	IN		KG	LB
350057	83	3 1/4"	280	6 5/8	EL60	59	12.9

BEG8 SYSTEM RODS

Long Hole MF Drill Tubes

PART #	WRENCH FLATS	LENGTH		ROD CROSS SECTION	THREAD	WEIGHT	
		MM	FT/IN			KG	LB
270004	No	1525	5'	87T	BE68	44.2	97.5
270064	No	1830	6'	87T	BE68	49.4	108.8

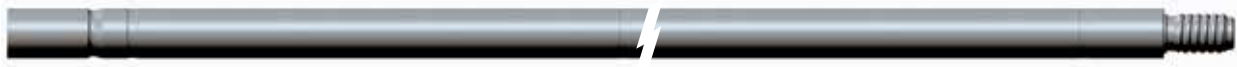

BEG8 SYSTEM BITS

Button Bits

PART #	DIAMETER		BUTTONS		FLUSHING HOLE	CARBIDE PROFILE	FACE PROFILE
	MM	IN	GAUGE NO/ SIZE	FRONT NO/ SIZE			
110927	102	4"	8 x 14	6 x 12	4F	Hemispherical / Parabolic	Recess
110280	127	5"	8 x 14	9 x 12	2F 2G	Hemispherical	Flat
110612	102	4"	9 x 12	7 x 12	3F	Hemispherical	Flat
110951	105	4 1/8"	9 x 14	7 x 14	3F	Hemispherical	Flat



BE68 SYSTEM REAMER TOOLS

Straightrac Button Bits

PART #	DIAMETER		BUTTONS		FLUSHING HOLE	CARBIDE PROFILE	FACE PROFILE								
	MM	IN	GAUGE NO/ SIZE	FRONT NO/ SIZE											
140195	102	4"	8 x 14	6 x 12	4F	Hemispherical / Parabolic	Recess								
															
140174	115	4 1/2"	9 x 14	6 x 14	3F	Hemispherical	Flat								
															
140049	102	4"	9 x 12	7 x 12	3F	Hemispherical	Flat								
								140089	102	4"	9 x 12	7 x 12	3F	Parabolic	Flat
															

Pilot Reamer Bits

PART #	DIAMETER		PILOT DIAMETER		BUTTONS		FLUSHING HOLE	CARBIDE PROFILE	WEIGHT	
	MM	IN	MM	IN	GAUGE NO/ SIZE	FRONT NO/ SIZE			KG	LB
990064	127	5"	90	3 9/16"	9 x 14	3x14 / 6x12	3F	Hemispherical	9.7	21.3
090047	152	6"	89	3 1/2"	9 x 16	6x16 / 6x12	3F	Hemispherical	13.5	29.8
990061	203	8"	135	5 5/16"	18 x 14	13 x 14	3F	Hemispherical	23.1	50.9



EL68 SYSTEM RODS

Long Hole MM Induction Hardened Rods



PART #	WRENCH FLATS	LENGTH		ROD CROSS SECTION	THREAD	WEIGHT	
		MM	FT/IN			KG	LB
							
203003	No	1000	3' 3 6/16"	70R	EL68	34.7	76.5
200428	No	1830	6'	70R	EL68	474	104.6
200426	No	3660	12'	70R	EL68	98.2	216.5
200431	No	4270	14'	70R	EL68	114.6	252.6
200424	No	6100	20' 3/16"	70R	EL68	164.2	361.9

Long Hole MF Lightning Rods

PART #	WRENCH FLATS	LENGTH		ROD CROSS SECTION	THREAD	WEIGHT	
		MM	FT/IN			KG	LB
							
210216	No	1220	4'	70R	EL68	379	83.4
210203	No	3660	12'	70R	EL68	103.8	228.8
210204	No	4270	14'	70R	EL68	120.3	265.2
210220	No	6100	20' 3/16"	70R	EL68	168.3	371.0

EL68 SYSTEM BITS

Button Bits

PART #	DIAMETER		BUTTONS		FLUSHING HOLE	CARBIDE PROFILE	FACE PROFILE
	MM	IN	GAUGE NO/ SIZE	FRONT NO/ SIZE			
							
110943	108	4 1/4"	8 x 16	6 x 16	2F	Parabolic	Flat
							
110675	115	4 1/2"	8 x 14	6 x 14	4F	Hemispherical	Recess
110676	115	4 1/2"	8 x 14	6 x 14	4F	Parabolic	Recess
							
110677	127	5"	8 x 14	7 x 14	4F	Hemispherical	Recess
110678	127	5"	8 x 14	7 x 14	4F	Parabolic	Recess
110679	140	5 1/2"	8 x 16	7 x 16	4F	Hemispherical	Recess
110681	152	6"	8 x 16	7 x 16	4F	Hemispherical	Recess
110682	152	6"	8 x 16	7 x 16	4F	Parabolic	Recess
							
110599	105	4 1/8"	9 x 12	7 x 12	3F	Hemispherical	Flat

EL68 SYSTEM BITS

Button Bits



PART #	DIAMETER		BUTTONS		FLUSHING HOLE	CARBIDE PROFILE	FACE PROFILE
	MM	IN	GAUGE NO/ SIZE	FRONT NO/ SIZE			
110940	152	6"	9 x 16	9 x 16	3F	Ballistic	Flat
110969	152	6"	9 x 16	9 x 16	3F	Hemispherical	Flat

Retrac Button Bits



PART #	DIAMETER		BUTTONS		FLUSHING HOLE	CARBIDE PROFILE	FACE PROFILE
	MM	IN	GAUGE NO/ SIZE	FRONT NO/ SIZE			
130070	127	5"	8 x 14	7 x 14	4F	Hemispherical	Recess
130134	140	5 1/2"	8 x 16	7 x 16	4F	Hemispherical	Recess
130135	152	6"	8 x 16	7 x 16	4F	Hemispherical	Recess

Straightrac Button Bits



PART #	DIAMETER		BUTTONS		FLUSHING HOLE	CARBIDE PROFILE	FACE PROFILE
	MM	IN	GAUGE NO/ SIZE	FRONT NO/ SIZE			
140217	152	6"	9 x 16	9 x 16	3F	Hemispherical	Flat

EL68 SYSTEM COUPLING

Semi-Bridge Couplings



PART #	DIAMETER		LENGTH		THREAD	WEIGHT	
	MM	IN	MM	IN		KG	LB
350051	96	3 3/4"	330	13	EL68	9.9	21.8

Full Bridge Couplings



PART #	DIAMETER		LENGTH		THREAD	WEIGHT	
	MM	IN	MM	IN		KG	LB
350052	96	3 3/4"	356	14	EL68	11.4	25.1



SHANK ADAPTERS

Boart Longyear	82
Atlas Copco	83
Cannon	86
Caterpillar / Gardner Denver	86
Furukawa	89
Ingersoll Rand	91
Montabert	91
PW	93
Sandvik / Tam Rock	93
SCM	97
SVK	97
Toyo	98
UDR	98

SHANK ADAPTERS

Intended for use with Boart Longyear Drills

PART #	ROCK DRILL	THREAD	LENGTH	STRIKE FACE	FRONTHEAD	SPLINE							
			MM	MM	MM	MM							
							450074	HE65	R32F	324	32	45	38
							450078	HE150	R32F	428	38	45	64
							450653	HD155	R32	575	38	55	81
							450652	HD155	R38	575	38	55	81
							450500	HD155	HM38	575	38	55	81
							450565	HD155	HM45	575	38	55	81
							450777	S140	HM38	495	45	45	63
							450778	S140	HM45	495	45	45	63
							450212	S36IR	R32	380	44	44	64
							450037	S36IR	R38	380	44	44	64
							450010	S36IR	HM45	380	44	44	64
							450266	S36IR	HM38	380	44	44	64

SHANK ADAPTERS

Intended for use with Atlas Copco Drills

PART #	ROCK DRILL	THREAD	LENGTH	STRIKE FACE	FRONTHEAD	SPLINE
			MM	MM	MM	MM
450853	COP 1132	R32	410	25	35	79
450914	COP 1132	R35	410	25	35	79
450854	COP 1132	R32	500	25	35	80
450089	COP 1032	R32F	340	34	45	59
450094	COP 1238ME	R32	575	34	38	74
450251	COP 1238ME	R38	575	34	38	74
450284	COP 1238ME	HM38	575	34	38	74
450150	COP 1238ME	R38	476	34	38	74
450286	COP 1238ME	HM38	476	34	38	74
450423	COP 1238ME	R38	486	34	38	74

SHANK ADAPTORS

Intended for use with Atlas Copco Drills

PART #	ROCK DRILL	THREAD	LENGTH	STRIKE FACE	FRONTHEAD	SPLINE
			MM	MM	MM	MM
450092	COP 1238ME	R32	500	34	38	74
450282	COP 1238ME	HM38	500	34	38	74
450524	COP 1238ME	HM38	575	34	45	74
450632	COP 1238ME	HM45	575	34	45	74
450889	COP 1838	HM38	525	34	52	84
450713	COP 1838ME	HM45	525	34	52	84
450539	COP 1838ME	HM51	525	34	52	84
450605	COP 1838ME	HM38	730	34	60	116
450607	COP 1838ME	HM45	730	34	60	116
450857	COP 1838MU	HM38	730	34	52	124
450856	COP 1838MU	HM45	730	34	52	124

SHANK ADAPTERS

Intended for use with Atlas Copco Drills

PART #	ROCK DRILL	THREAD	LENGTH	STRIKE FACE	FRONTHEAD	SPLINE
			MM	MM	MM	MM
450614	COP 1838T	R32	435	36	38	84
450631	COP 1838T	R32	525	36	38	84
450469	COP 1838T	R38	435	36	38	84
450550	COP 1838T	HM38	435	36	38	84
450551	COP 1838T	HM38	525	36	38	84
450548	COP 1840ME	HM45	565	35	52	126
450634	COP 1840ME	HM51	565	35	52	126
450858	COP 2160	HM51	770	37	63	156
450916	COP 3060	BE58	745	50	90	144
450863	COP 4050	BE58	834	46	90	134
450826	COP 4050	BE68	834	46	90	134
450878	COP 4050	EL60	700	52	70	109

SHANK ADAPTERS

Intended for use with Atlas Copco Drills

PART #	ROCK DRILL	THREAD	LENGTH	STRIKE FACE	FRONTHEAD	SPLINE
			MM	MM	MM	MM
450909	COP 4050	BE58	834	46	90	113

Intended for use with Cannon Drills

PART #	ROCK DRILL	THREAD	LENGTH	STRIKE FACE	FRONTHEAD	SPLINE
			MM	MM	MM	MM
450855	JH2	R32F	390	38	55	76
450454	JH2	HM38F	390	38	55	76

Intended for use with Caterpillar / Gardner Denver Drills

PART #	ROCK DRILL	THREAD	LENGTH	STRIKE FACE	FRONTHEAD	SPLINE
			MM	MM	MM	MM
450895	HPR1	HM38	787	38	44	97
450667	HPR1H	HM38	744	44	44	89
450629	HPR1H	HM45	744	44	44	89

SHANK ADAPTERS

Intended for use with Caterpillar / Gardner Denver Drills

PART #	ROCK DRILL	THREAD	LENGTH	STRIKE FACE	FRONTHEAD	SPLINE							
			MM	MM	MM	MM							
							450896	HPR1HRP	HM45	953	44	44	129
							450002	PR1000	R32	499	44	44	64
							450014	PR1000	R32	510	44	44	64
							450643	HPR3818	R38	559	38	38	70
							450644	HPR3818	HM38	559	38	38	70
							450899	HPR3818B	HM45	563	38	44	97

SHANK ADAPTERS

Intended for use with Caterpillar / Gardner Denver Drills

PART #	ROCK DRILL	THREAD	LENGTH	STRIKE FACE	FRONTHEAD	SPLINE
			MM	MM	MM	MM
450902	HPR3818B	HM51	563	38	54	97
450825	HPR5123	HM45	770	51	51	89
450824	HPR5123	HM51	770	51	51	89
450861	HPR5123	EL60	770	51	51	89
450646	HPR5128	HM45	914	51	51	99
450638	HPR5128	HM51	914	51	51	99
450640	HPR6832	HM51	1041	64	70	101
450785	HPR6832	EL60	1041	64	70	101
450582	HPR6832	EL68	1041	64	70	101
450818	HPR4519	HM38	770	44	44	89
450760	HPR4519	HM45	770	44	44	89

SHANK ADAPTERS

Intended for use with Caterpillar / Gardner Denver Drills

PART #	ROCK DRILL	THREAD	LENGTH	STRIKE FACE	FRONTHEAD	SPLINE
			MM	MM	MM	MM
450890	HPR6030	HM51	1041	60	60	102
450891	HPR6030	EL60	1041	60	60	102

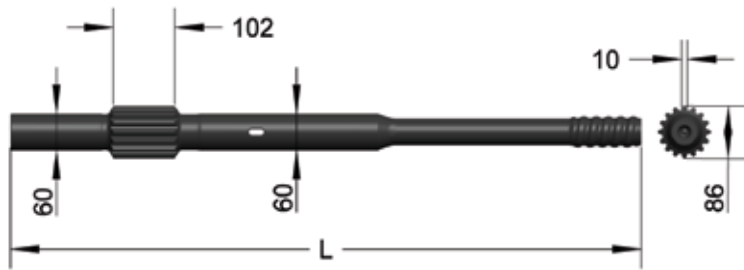

Intended for use with Furukawa Drills

PART #	ROCK DRILL	THREAD	LENGTH	STRIKE FACE	FRONTHEAD	SPLINE
			MM	MM	MM	MM
450771	HD90	R32	515	32	40	54
450752	HD210	R38	409	41	40	75
450761	HD210	HM38	409	41	40	75
450459	HD300	R38	655	44	44	80
450442	HD300	HM38	655	44	44	80
450443	HD300	HM45	654	44	44	80
450745	HD500	HM45	711	50	52	100
450477	HD500	HM51	710	50	52	100

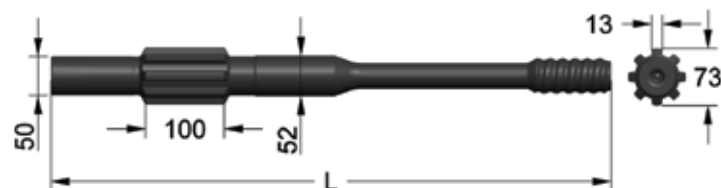
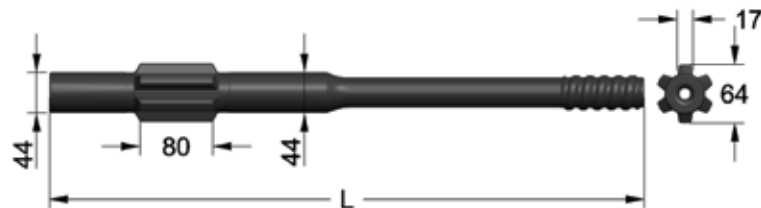
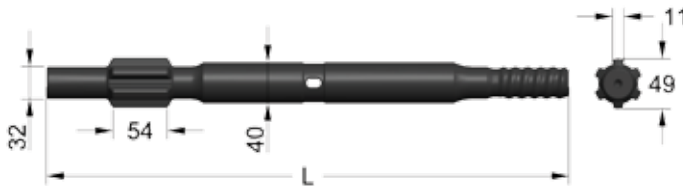

SHANK ADAPTORS

Intended for use with Furukawa Drills

PART #	ROCK DRILL	THREAD	LENGTH	STRIKE FACE	FRONTHEAD	SPLINE
			MM	MM	MM	MM
450487	HD609	HM38	690	36	45	75
450525	HD609	HM45	690	36	45	75
450576	HD612	HM45	710	42	51	92
450842	HD709	HM38	622	44	45	93
450793	HD709	HM45	622	44	45	93
450743	HD712	HM45	780	50	51	123
450795	HD712	HM45	790	50	51	100
450801	HD712	HM51	790	50	51	100
450823	HD715	HM51	882	58	58	164

SHANK ADAPTERS

Intended for use with Ingersoll Rand Drills

PART #	ROCK DRILL	THREAD	LENGTH	FACE	FRONTHEAD	SPLINE
			MM	MM	MM	MM

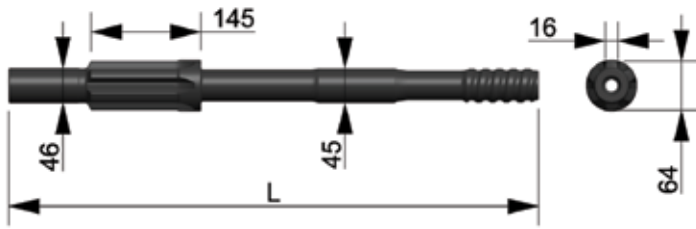

450468	YH65	HM45	700	46	45	145
--------	------	------	-----	----	----	-----

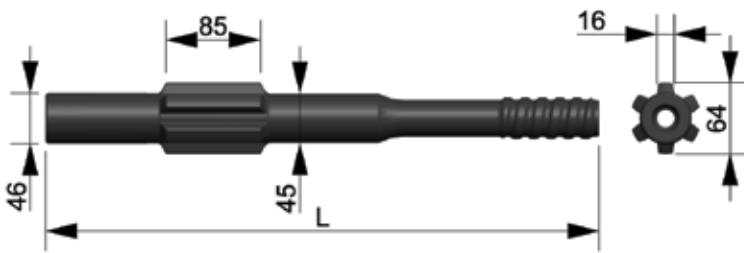

450460	YH65	HM38	500	46	45	85
450375	YH65	HM45	500	46	45	85

Intended for use with Montabert Drills

PART #	ROCK DRILL	THREAD	LENGTH	FACE	FRONTHEAD	SPLINE
			MM	MM	MM	MM



450314	HC40	R38	390	38	38	58
--------	------	-----	-----	----	----	----



450455	HC40	R32	447	38	38	58
450438	HC40	HM38	447	38	38	58

SHANK ADAPTORS

Intended for use with Montabert Drills

PART #	ROCK DRILL	THREAD	LENGTH	FACE	FRONTHEAD	SPLINE							
			MM	MM	MM	MM							
							450862	HC50	R32F	270	35	45	51
							450485	HC80	R32	440	38	38	97
							450586	HC80	HM38	447	38	38	97
							450172	HC80 H	HM38	500	38	38	97
							450613	HC120	HM38	490	39	45	97
							450612	HC120	HM45	490	39	45	97
							450753	HC120	HM45	670	38	45	102

SHANK ADAPTERS

Intended for use with PW Drills

PART #	ROCK DRILL	THREAD	LENGTH	FACE	FRONTHEAD	SPLINE
			MM	MM	MM	MM

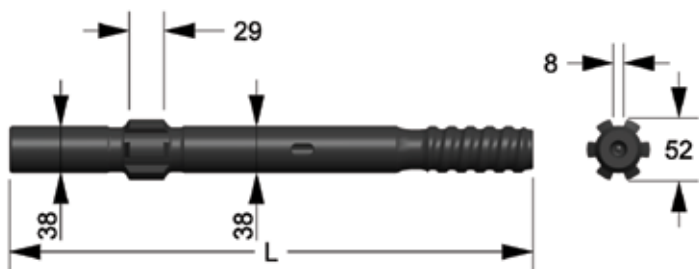

450839	131	HM38	432	38	38	29
--------	-----	------	-----	----	----	----

Intended for use with Sandvik / Tam Rock Drills

PART #	ROCK DRILL	THREAD	LENGTH	FACE	FRONTHEAD	SPLINE
			MM	MM	MM	MM

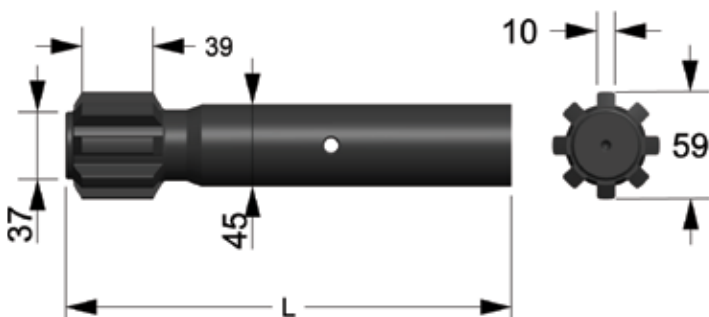

450475	HL300	R32F	245	37	45	39
--------	-------	------	-----	----	----	----

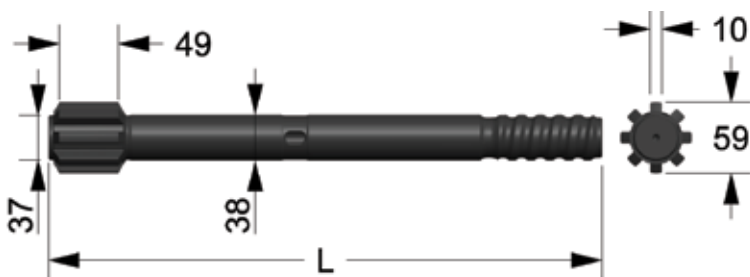

450408	HL500	R32	460	37	38	49
450407	HL500	R38	460	37	38	49
450405	HL500	HM38	460	37	38	49

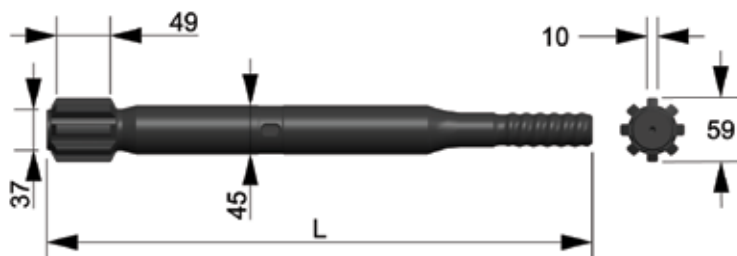

450594	HL550	R32	500	37	45	49
450871	HL550	HM35	460	37	45	49
450466	HL550	R38	500	37	45	49
450445	HL550	HM38	500	37	45	49

SHANK ADAPTORS

Intended for use with Sandvik / Tam Rock Drills

PART #	ROCK DRILL	THREAD	LENGTH	FACE	FRONTHEAD	SPLINE
			MM	MM	MM	MM
450382	HL600	HM38	600	40	45	75
450383	HL600	HM45	600	40	45	75
450533	HL600	HM51	650	40	52	75
450427	HL600	R32	525	40	45	75
450430	HL600	HM45	525	40	45	75
450636	HL600	HM38	525	40	45	75
450870	HL650	HM38	600	42	45	95
450868	HL650	HM45	600	42	45	95
450700	HL700	HM38	600	42	52	95
450603	HL700	HM45	600	42	52	95
450575	HL700	HM51	600	42	52	95

SHANK ADAPTERS

Intended for use with Sandvik / Tam Rock Drills

PART #	ROCK DRILL	THREAD	LENGTH	FACE	FRONTHEAD	SPLINE
			MM	MM	MM	MM



450380	HL1000	HM45	670	50	52	75
450111	HL1000	HM51	670	50	52	75



450412	HL1000	BE58	624	50	80	75
450591	HL1000	BE68	639	50	80	75

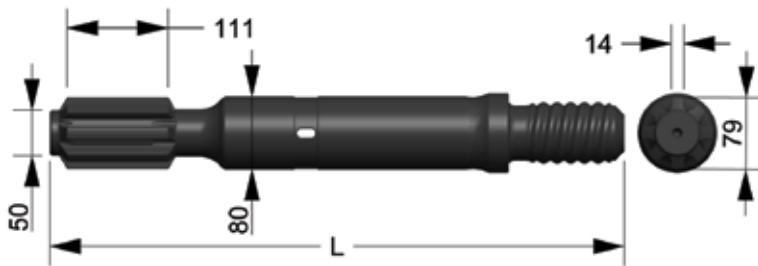

450671	HL1500	BE68	632	50	80	111
450783	HL1500	BE58	614	50	80	111

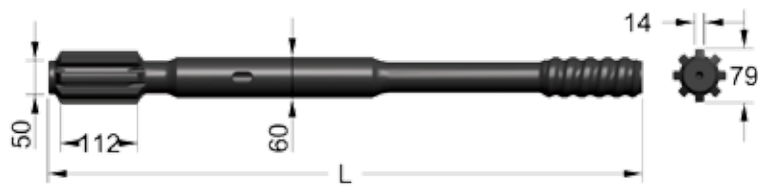

450781	HL1500	EL60	870	50	60	112
--------	--------	------	-----	----	----	-----

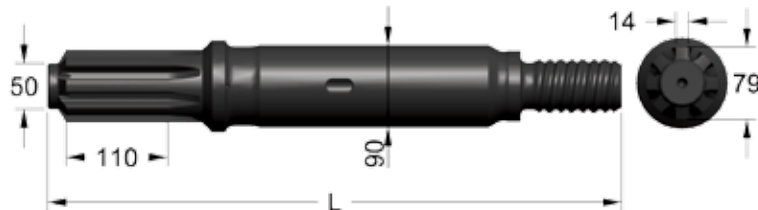

450835	HL1500	BE58	625	50	90	110
--------	--------	------	-----	----	----	-----

SHANK ADAPTORS

Intended for use with Sandvik / Tam Rock Drills

PART #	ROCK DRILL	THREAD	LENGTH	FACE	FRONTHEAD	SPLINE
			MM	MM	MM	MM
450841	HL1560	HM51	760	50	80	112
450840	HL1560	EL60	760	50	80	112
450873	HL1560	HM51	760	50	65	106
450846	HL1560	EL60	760	50	65	106
450852	HLX5	R38	500	37	45	49
450851	HLX5	HM38	500	37	45	49
450816	HLX5	HM38	575	37	45	49
450836	HLX5	HM45	575	37	45	95

SHANK ADAPTERS



450827	HLX5	HM38	519	37	45	49
--------	------	------	-----	----	----	----

Intended for use with SCM Drills

PART #	ROCK DRILL	THREAD	LENGTH	FACE	FRONTHEAD	SPLINE
			MM	MM	MM	MM

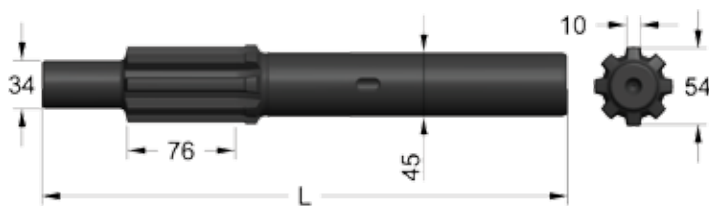

450747	HYD200	R28F	370	34	45	79
--------	--------	------	-----	----	----	----

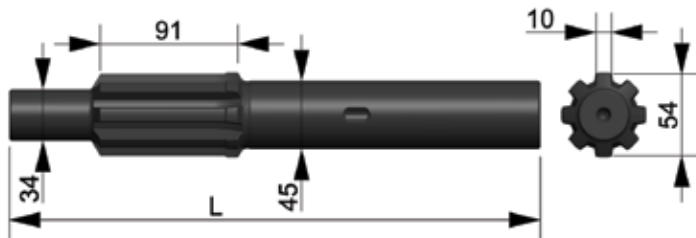

450335	HYD200	R32F	350	34	45	91
--------	--------	------	-----	----	----	----

Intended for use with SVK Drills

PART #	ROCK DRILL	THREAD	LENGTH	FACE	FRONTHEAD	SPLINE
			MM	MM	MM	MM

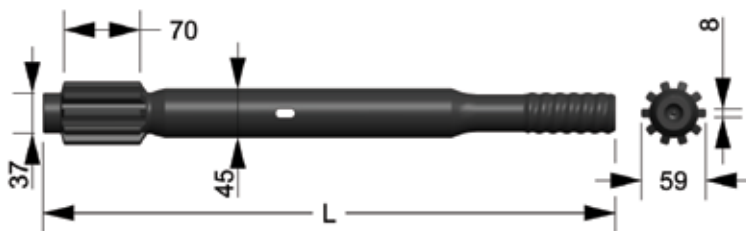

450879	RD520	R38	525	37	45	70
450872	RD520	HM38	525	37	45	70

SHANK ADAPTERS

Intended for use with Toyo Drills

PART #	ROCK DRILL	THREAD	LENGTH	FACE	FRONTHEAD	SPLINE
			MM	MM	MM	MM

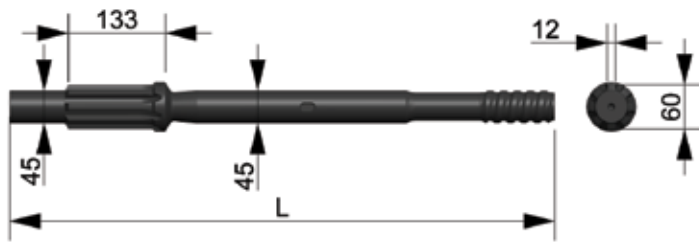

450763	TH921	HM45	750	45	45	133
--------	-------	------	-----	----	----	-----

Intended for use with UDR Drills

PART #	ROCK DRILL	THREAD	LENGTH	FACE	FRONTHEAD	SPLINE
			MM	MM	MM	MM

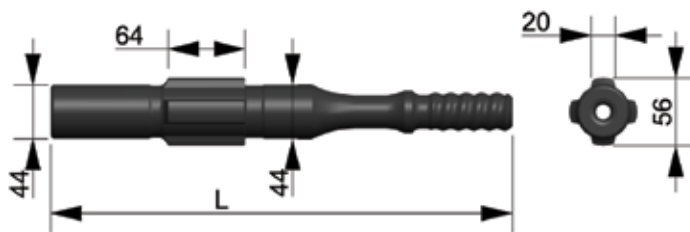

450013	UDR475	R32	380	44	44	64
--------	--------	-----	-----	----	----	----

ACCESSORIES

Adapter Couplings	100
Male/ Female Bit Adapters	100
Spiral Male / Female Bit Adapters	100
Male / Female Adapter Guides	101
Split Set Drivers	101
Driver Nuts	102
Spear – Female End	102
Spear – Male End	102
Bell Taps	103
Knock Off Blocks	103
Reaming Shell Adapters	103
Bit Resharpener Gauge	104
H22 Chuck Gauge	104

ACCESSORIES

Adapter Couplings



PART #	DIAMETER		LENGTH		THREAD	WEIGHT	
	MM	IN	MM	IN		KG	LB
360029	45	1 3/4"	168	6 5/8"	R32 / R25	15	3.2
360030	45	1 3/4"	168	6 5/8"	R32 / R28	1.3	2.9
360017	55	2 3/16"	171	6 3/4"	R38 / R32	2.2	4.7
360008	66	2 5/8"	205	8 1/16"	R38 / HM45	3.6	7.9
360018	55	2 3/16"	178	7	HM38 / R32	2.2	4.8
360031	55	2 3/16"	181	7 1/8"	HM38 / R38	2.0	4.5
360014	66	2 5/8"	210	8 3/4"	HM45 / HM38	3.5	7.7
360035	83	3 1/4"	276	10 7/8"	HM51 / HM45	5.4	11.9
360045	83	3 3/4"	276	10 7/8"	EL60 / HM51	8.7	19.1
360039	96	3 3/4"	305	12	EL68 / HM51	12.7	28.0

Male / Female Bit Adapters



PART #	MALE THREAD	FEMALE THREAD	LENGTH	
			MM	IN
370038	R28	R32	222	8 3/4"
370022	R32	R25	200	7 7/8"
370035	R32	R28	203	8"
370052	R32	R35	241	9 1/2"
370037	R32	HM38	222	8 3/4"
370009	HM38	R32	292	11 1/2"
370031	HM38	HM45	292	11 1/2"
370008	R38	R32	235	9 1/4"
370014	HM45	HM38	254	10"
370045	HM45	R32	222	8 3/4"
370049	HM45	HM51	285	11 1/4"
370015	HM51	HM45	305	12"
370050	HM51	EL60	336	13 1/4"
370051	EL60	EL68	393	15 1/2"
370047	BE68	HM51	289	11 3/8"

Spiral Male / Female Bit Adapters



PART #	MALE THREAD	FEMALE THREAD	LENGTH	
			MM	IN
400012	HM38	HM38	324	12 3/4"
400015	HM45	HM45	343	13 1/2"

ACCESSORIES

Male / Female Adapter Guides



PART #	THREAD	SIZE	LENGTH	
			MM	IN
				
400021	HM38	64mm	700	27 9/16"
400022	HM45	76mm	708	27 7/8"
400023	HM45	89mm	708	27 7/8"
400025	HM51	89mm	724	28 1/2"

Split Set Drivers

PART #	THREAD	WEIGHT	
		KG	LB
			
560017	R38	250	9 13/16"
560001	CLR	250	9 13/16"
560082	CLR	330	13"
560014	11 *	190	7 1/2"
560079	12 *	200	7 7/8"
560040	R28	190	7 1/2"
560083	R38	762	30"
560081	CLR	330	13"
560085	CLR	1175	46 1/4"
560015	11 *	190	7 1/2"
560080	12 *	200	7 7/8"
560016	R25	190	7 1/2"
560092	R25	191	7 1/2"
560026	R32	450	17 11/16"

ACCESSORIES

Driver Nuts

	PART #	THREAD	DRIVER NUT TYPE	LENGTH	
				MM	IN
	560069	CLR	7/8 Hex	124	4 7/8"
	560063	CLR	7/8 Hex	416	16 3/8"
	560054	CLR	30 Square	229	9"
	560052	CLR	30 Square	336	13 1/4"
	560019	CLR	30 Square	610	24"
	560021	CLR	30 Square	900	35 7/16"
	560023	CLR	30 Square	1520	59 13/16"
	560078	R25F	30 Square	280	11"
	560036	R38F	29 Square	250	9 13/16"

Spear - Female End

	PART #	THREAD
	620004	R32
	620007	HM45
	620008	HM51
	62022	EL60
	62023	EL68

Spear - Male End

	PART #	THREAD
	620006	HM38
	620016	BE58
	620015	BE68

ACCESSORIES

Bell Taps



PART #	THREAD
630010	R25
630004	R32
630006	HM38
630007	HM45
630008	HM51
630013	EL60
620013	EL68

Knock Off Blocks

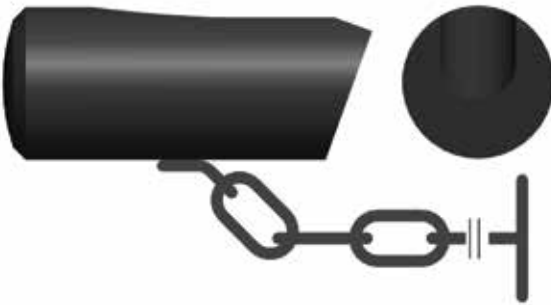

PART #	THREAD
660001	H22
660003	H22RMG

Reaming Shell Adapters



PART #	THREAD	SIZE
380019	TPR	11°
690001	TPR	12°

ACCESSORIES

Bit Resharpening Gauge

PART #

3542857

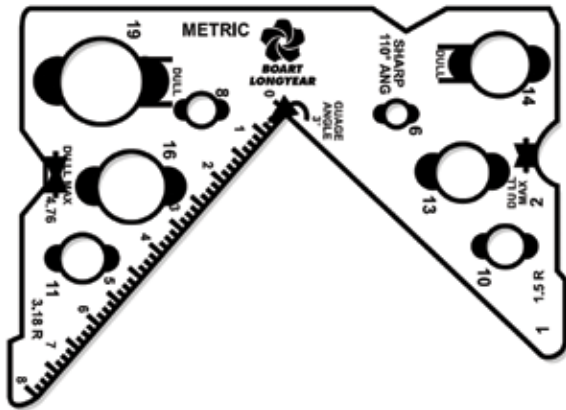

H22 Chuck Gauge

PART #

5600005



TROUBLESHOOTING

Collared and Tapered Rods	106
Blade Bits	108
Button Bits	109
Couplings	112
Shank Adapters	113
Drill Steels	115

COLLARED AND TAPERED RODS

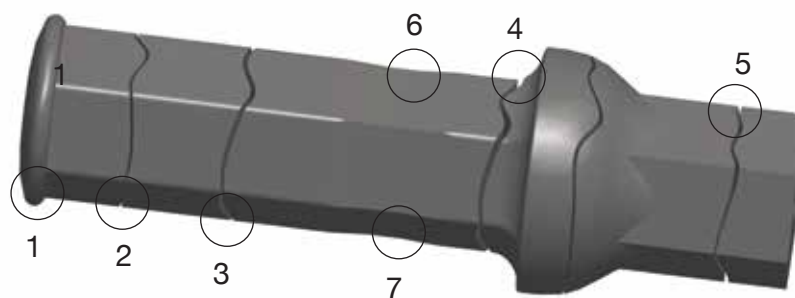

FAILURE	PROBABLE CAUSE	RECOMMENDED ACTION
POSITION - 1 Mushrooming of striking end	i) Worn chuck bushing	i) Replace worn bushing
	ii) Dished piston	ii) Replace worn piston
	iii) Worn tappet or tappet bushing	iii) Replace tappet and/or bushing
POSITION - 2 Failure at beginning of shank end	i) Worn chuck bushing	i) Replace worn bushing
POSITION - 3	i) High polish generated by chuck bushing. Lack of lubrication or excessive flushing water pressure	i) Check operation pressures - lubrication, water and air pressure
	ii) Worn bushing	ii) Replace worn bushing
POSITION - 4 Breakage at beginning of collar radius	i) Poor chuck bushing radius causing indentation of the collar	i) Replace worn bushing
	ii) Overheating due to lack of lubrication	ii) Proper lubrication
	iii) Misalignment due to excessive play in bushing	iii) Replace worn bushing
POSITION - 5 Broken in bar	i) Normally associated with rod alignment	i) Keep rod alignment as close as possible
POSITION - 6 Shank wear or coke bottle wear	i) Worn chuck bushing	i) Replace worn bushing

COLLARED AND TAPERED RODS

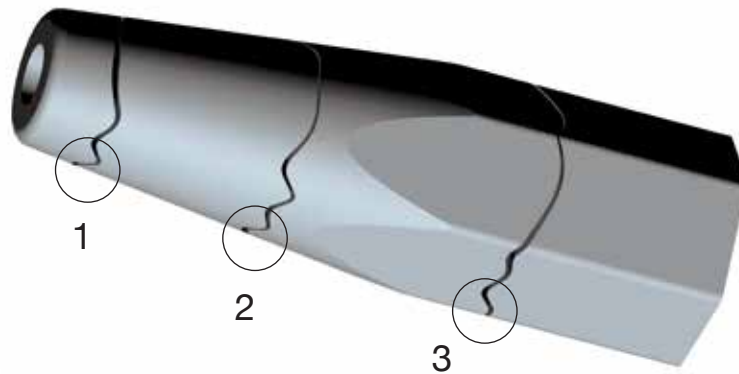

FAILURE	PROBABLE CAUSE	RECOMMENDED ACTION
POSITION - 1 Breakage at beginning of taper radius	i) Worn bit socket	i) Discard bit
	ii) Improper reconditioning of rod taper	ii) Replace or recondition drill steel
	iii) Using a damaged bit with a ridge or lip within the socket	iii) Discard bit or ream out ridge
POSITION - 2 Breakage at end of taper radius	i) Worn bit socket	i) Discard bit
	ii) Improper reconditioning of rod taper	ii) Replace or recondition drill steel
	iii) Using a damaged bit with a ridge or lip within the socket	iii) Discard bit or ream out ridge
POSITION - 3 Breakage at bar	i) Normally associated with rod alignment	i) Keep rod alignment as close as possible

BLADE BITS

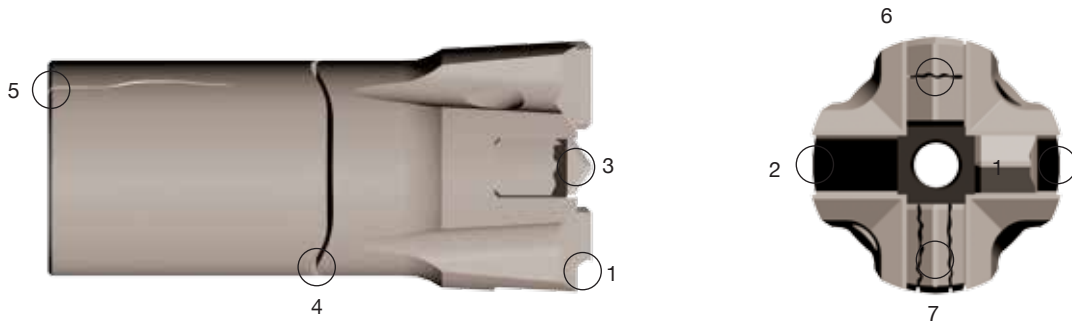

FAILURE	PROBABLE CAUSE	RECOMMENDED ACTION
POSITION - 1 Insert corner fractured	i) Pinching in the hole by drilling into hole that was drilled with a smaller bit	i) Colour code bits by size to reduce opportunity for negative gauge clearance. Drill with the bit with the largest gauge thread reducing to smaller.
	ii) Overdrilling - excessive gauge wear	ii) Resharpener bit when corner wear is no greater than 4.76 mm (3/16")
	iii) Improper bit sharpening	iii) Resharpen bit to its original shape. Follow proper bit sharpening procedures
POSITION - 2 Insert detached from slot	i) Braze failure - fatigue of braze material	i) Review drilling practice, resharpening
POSITION - 3 Insert shattered	i) Overdrilling - excessive gauge wear	i) Resharpen bit when wear flat no greater than 3.175 mm (1/8")
	ii) Incorrect grade of carbide	ii) Utilize heavy duty grade
	iii) Overheating bit when resharpening	iii) Resharpening bit to its original shape. Follow proper bit sharpening procedures
	iv) Insufficient flushing	iv) Increase flushing pressure
POSITION - 4 Skirt wring off	i) Improper or worn taper	i) Utilizing a taper gauge, check taper angle
	ii) Drilling with broken taper	ii) Remove drill steel from circuit and refurbish
POSITION - 5 Skirt split	i) Improper or worn taper	i) Utilizing a taper gauge check taper angle
POSITION - 6 Traverse crack	i) Carbide grade too hard	i) Select bit with a softer, more tough grade of carbide
POSITION - 7 Longitudinal cracks	i) Overdrilling - excessive flat	i) Resharpen bit when wear flat no greater than 3.175 mm (1/8")

BUTTON BITS

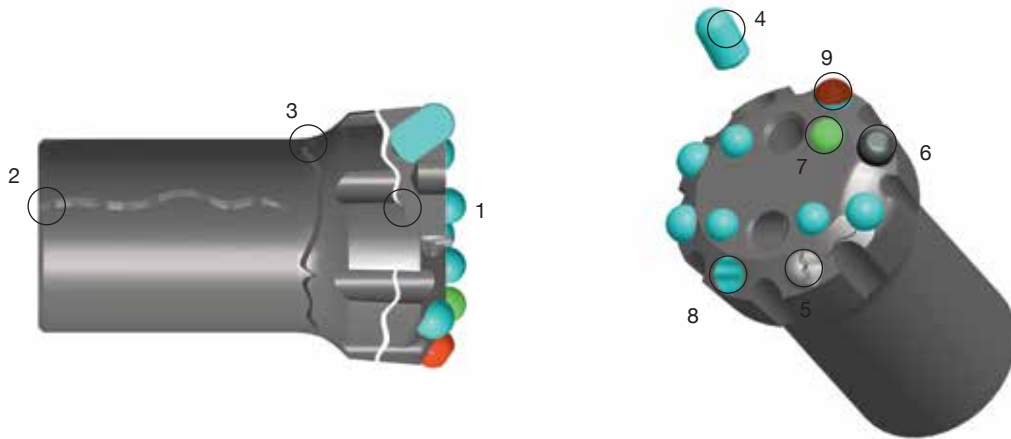

FAILURE	PROBABLE CAUSE	RECOMMENDED ACTION
POSITION - 1 Body wash	i) Inadequate bailing	i) Check to ensure that maximum available flushing is employed. If bailing appears to be inadequate, try cleaning holes thoroughly after drilling each steel length. Continued drilling with poor bailing will wear bit bodies excessively
	ii) Drilling and excessive hole cleaning in loose and fractured material	ii) Do not use new bits in these applications. Use bits approaching the end of their usable life. Bits with missing buttons unsuitable for regular drilling can still be suitable for soft or broken ground conditions
POSITION - 2 Split skirt	i) Bit loose on rod	i) Do not engage percussion until bit is seated on rod
	ii) Hammering on bit to break connection	ii) Loosen bit while seated firmly on face or at bottom of the hole
POSITION - 3 Wring off	i) High rotation torque applied to stuck bit	i) Apply minimal amount of hammer pressure to free bit before increasing rotation pressures
	ii) Corrosion	ii) Inspect thread socket for pitting and rust
	iii) Breaking connection by hammering on bit	iii) Loosen bit while seated firmly on face or at bottom of the hole

BUTTON BITS

FAILURE	PROBABLE CAUSE	RECOMMENDED ACTION
POSITION - 4 Lost gauge button	i) Dry firing	i) Do not engage full percussion unless the bits are seated firmly against solid material. Use reduced percussion when collaring on uneven surfaces if the bits hang up in the hole and when ratting the drill string to loosen connections
	ii) Excessive bit body reduction through erosion from poor flushing or excessive bit body grinding	ii) Ensure the drill cuttings are adequately bailed. Avoid drilling in broken and fractured material where excessive hole cleaning or back drilling is required. Remove only the amount of body required to restore proper button protrusion while grinding
	iii) Scaling with bit	iii) Use proper scaling tools
POSITION - 5 Shattered buttons	iv) Interference too low when button fitted	iv) Forward for analysis
	i) Overdrilling	i) 90% of all button failures are the direct result of continuing to drill with excessive wear flats on the buttons! Remove and service bits once the wear flat on any button reaches 1/3 of the face button diameter. Restore the button profile and protrusion as recommended in the bit sharpening guide before continuing use
	ii) Drilling into metal	ii) Even new buttons will break when encountering foreign material like stuck steel, bits, rebar or any other metals trapped in the rock
	iii) Forceful rotation in undersize holes, in broken material or through voids in the rock	iii) Check that bit diameters are smaller than the hole before attempting to clean or deepen a hole under these conditions. Do not force bits if jamming occurs. Retract until rotating freely then advance slowly with moderate rotation. If this fails, use a scrapped bit or grind down the gauge buttons of the bit to reduce the diameter sufficiently to pass or remove the obstruction
	iv) Snake skin fatigue from extended drilling in non-abrasive material	iv) Over drilling in soft non-abrasive material leaves a shiny surface on the buttons. Under magnification, a network of microscopic cracks can typically be found. Regularly inspect the bits and re-profile the buttons to remove these cracks from the surface of the carbides once the skin on the carbides starts to show

BUTTON BITS

FAILURE	PROBABLE CAUSE	RECOMMENDED ACTION
POSITION - 6 Sheared buttons above or below the bit body	i) Forceful rotation against intrusions, in broken material or through voids in the rock	i) Jerky rotation and stalling indicates obstructions in the hole. Do not force bits if this occurs. Retract the string until free rotation is restored. Then advance slowly with moderate rotations until obstacle is passed or removed. If this fails, use scrapped bits, a smaller diameter bit or grind down the gauge buttons of the bit to reduce the diameter sufficiently to pass or remove the obstruction
	ii) Poor collaring	ii) First, ensure mast is secure. Start collar then full pressure once bit is embedded 300 mm (12.0") in the rock
	iii) Excessive button protrusion through incorrect sharpening	iii) Protrusions greater than 3/4 of the button diameter will not provide sufficient support to resist the tensile forces that the buttons may encounter
	iv) Deformation of the upper portion of the button hole. Possible overheating of the bits through improper use	iv) The bit body temperature during drilling can reach 200° C (392° F) reducing retention force significantly
POSITION - 7 Split button	i) Overdrilling	i) 90% of all button failures are the direct result of continuing to drill with excessive wear flats on the buttons. Remove and service bits once the wear flat on any button reaches 1/3 of the face button diameter. Restore the button profile and protrusion as recommended in the bit sharpening guide before continuing use
POSITION - 8 Button wear 1/3 diameter	i) Normal button wear	i) Resharpen button and restore to original profile
POSITION - 9 Snake skin, shiny- polished appearance	i) When drilling in non-abrasive rock, microfractures develop in carbide	i) Resharpen bits frequently even if no visible wear is evident

COUPLINGS

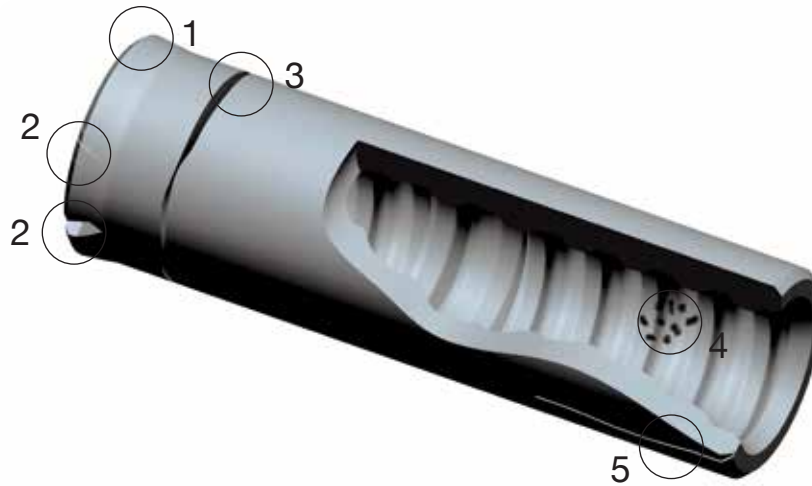

FAILURE	PROBABLE CAUSE	RECOMMENDED ACTION
POSITION - 1 Mushrooming of end	i) Hammering on the centralizer	i) Utilize a breakout plate
POSITION - 2 Coupling end is chipped, cracked and/or flared	i) Drill rod not firmly seated into the coupling from mismatch of threads	i) It is important to standardize on single source supplier for components to ensure proper thread tolerance. Do not “mix & match”
	ii) Mixing old thread components with new	ii) Install new couplings with new drill steels
	iii) Misalignment of feed	iii) Service affected equipment
	iv) Previous overheating of coupling	iv) The maximum running temperature for couplings is 182° C (276° F)
	v) Improper heat treatment	v) Forward for analysis
	vi) Dropping steel when retracting on upholes	vi) Use rockdrill with shank thread engaged to lower steel
	vii) Starting percussion or rotation with end of the shank resting against the end of the coupling	vii) Do not engage percussion or rotation if shank thread end is not aligned inside coupling
POSITION - 3 Failure across thread section	i) Hole deviation or misalignment of the feed in relation to the hole direction	i) Employ straight hole drilling devices
	ii) Low feed pressure	ii) Monitor feed force and tune to conditions
	iii) Heavy rotational loads from drilling with dull bits	iii) Resharpen bits when the wear flats appear 1/3 dull or discard when carbide profile height is compromised
	iv) Surface layer of steel compromised by a nick or dent	iv) Avoid hammering on connection. Use a breakout plate to loosen joints. Employ proper care and handling
POSITION - 4 Pitting or galling in the threads	i) Unused blow energy being reflected and absorbed	ii) Adjust percussion and feed pressures to rock conditions
	ii) Drilling with dull bits	ii) Resharpen bits when the wear flats appear 1/3 dull or discard when carbide profile height is compromised
POSITION - 5 Split coupling	i) Drilling with worn threads	i) Replace couplings more frequently
	ii) Excessive feed pressure	ii) Monitor feed force and tune to conditions

SHANK ADAPTERS



FAILURE	PROBABLE CAUSE	RECOMMENDED ACTION
POSITION - 1 Impact marks, chipped corners, mushroomed end	i) Misalignment due to worn bushings	i) Replace worn components
	ii) Damaged piston	ii) Replace worn components
POSITION - 2 Failure approx. 25 mm (1.0") from strike face	i) Worn chuck driver	i) Replace worn components
	ii) Fatigue starting at water seal recess	ii) Forward for analysis
POSITION - 3 Failure at top of splines	i) Lack of lubrication	i) Grease rockdrill regularly
	ii) Excessive feed force	ii) Monitor coupling temperatures and adjust feed pressure according to recommendations
	iii) Worn chuck driver or front bushing	iii) Replace worn components
POSITION - 4 Failure across splines	i) Worn chuck driver	i) Replace worn components
	ii) Heavy rotational torque	ii) Adjust drilling pressures
	iii) Lack of lubrication	iii) Grease rockdrill regularly
	iv) Overdrilling bits excessive wear flats and insufficient button protrusion	iv) Resharpen bits when the wear flats appear 1/3 dull or discard when carbide profile height is compromised. Inspect bits and select only bits with adequate protrusion and proper button profile for most cost effective drilling.
	v) Inadequate feed force	v) Monitor coupling temperatures and adjust feed pressure according to recommendations
POSITION - 5 Wear on bottom of spline shoulder	i) Excessive rotation while retracting string	i) Adjust drilling pressures
POSITION - 6 Failure at bottom of splines	i) Excessive rotation while retracting string	i) Adjust drilling pressures
POSITION - 7 Failure at fronthead	i) Misalignment from worn front bushing	i) Replace worn components
	ii) Lack of lubrication	ii) Grease rockdrill regularly
POSITION - 8 Failure above threads	i) Misalignment of drill feed while drilling	i) Utilize alignment tools to monitor hole orientation once the hole has been collared. Replace wear pads on feed
	ii) Hole deviation	ii) Employ straight hold drilling devices or systems
	iii) Excessive feed force	iii) Monitor coupling temperatures and adjust feed pressure according to recommendations

SHANK ADAPTERS

FAILURE	PROBABLE CAUSE	RECOMMENDED ACTION
POSITION - 9 Failure in main body of threads	i) Mismatched threads	i) Use only certified original Boart Longyear component from authorized or licensed manufacturers
	ii) Lack of lubrication	ii) Grease rockdrill regularly
	iii) Too much play in coupling. Shank Adapter improperly joined in coupling as a result of a thread wear	iii) Replace worn components. Do not put a worn coupling on a new rod. Change out couplings with new shank adapters
	iv) Excessive rattling	iv) Avoid extensive rattling. Boart Longyear threads are designed for easy uncoupling. If connectors do not loosen freely, inspect the threads. Probably causes of tightly threaded connections are: (1) dull bits; (2) worn or tight-fitting threads on steel or couplings; (3) incorrect or tight-fitting threads; and (4) insufficient or ineffective thread grease.
POSITION - 10 Failure close to bottom of thread	i) Excessive percussive pressure	i) Monitor coupling temperature during drilling; adjust percussive pressures
	ii) Broken drill steel	ii) Replace drill steel
	iii) Worn coupling	iii) Replace worn components. Do not put a worn coupling on a new rod. Change out your couplings with new rods
POSITION - 11 Chipped thread end	i) Shank Adapter not properly coupled to drill steel	i) Replace damaged or worn couplings
	ii) Broken drill steel	ii) Replace drill steel
	iii) Shank Adapter dropped into coupling	iii) Inspect feed for misalignment
POSITION - 12 Pitting and galling on threads	i) Overdrilling bit. Excessive wear flats and insufficient butt protrusion	i) Resharpen bits when the wear flats appear 1/3 dull or discard when carbide profile height is compromised. Inspect bits and select only bits with adequate protrusion and proper button profile for most cost effective drilling
	ii) Lack of lubrication	ii) Grease rockdrill regularly
	iii) Inadequate feed force	iii) Monitor coupling temperatures and adjust feed pressure according to recommendations
POSITION - 13 Pitting and galling on splines	i) Lack of lubrication	i) Grease rockdrill regularly
	ii) Excessive rotation in soft or broken ground	ii) Adjust drilling pressures
POSITION - 14 Excessive wear on top of spline shoulder	i) Excessive feed force	i) Monitor coupling temperatures and adjust feed pressure according to recommendations
	ii) Lack of lubrication	ii) Grease rockdrill regularly

DRILL STEELS

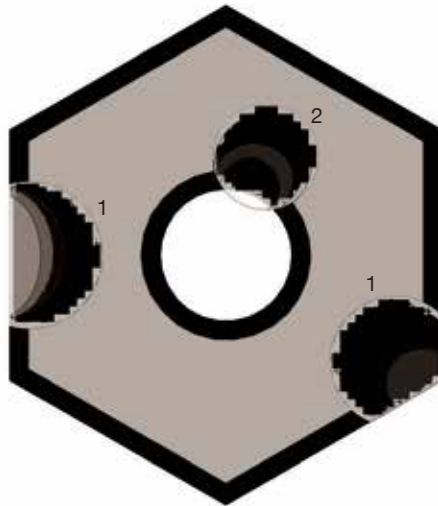

FAILURE	PROBABLE CAUSE	RECOMMENDED ACTION
POSITION - 1 Characterized by a fatigue rose origination from the outer surface. Surface layer of steel compromised by a nick or dent.	i) Surface damage caused by worn out centralizer bushings or steel bushings	i) Replace centralizer if diameter is 5 mm (1/2") larger than the drill steel
	ii) Using a hammer on a stuck steel	ii) Use a rod wrench to twist the stuck steel to loosen
	iii) Improper care and handling	iii) Store rods in a rod rack when retracting drill string. Do not drop rods
POSITION - 2 Characterized by a fatigue rose originated in the bore	i) Corrosion	i) Evaluate proper storage practices are being followed
	ii) Corrosion caused by brine and other corrosive flushing agents	ii) Change out components more frequently or neutralize flushing agent
	iii) Improper corrosion treatment during manufacturing	iii) Forward for analysis

DRILL STEELS

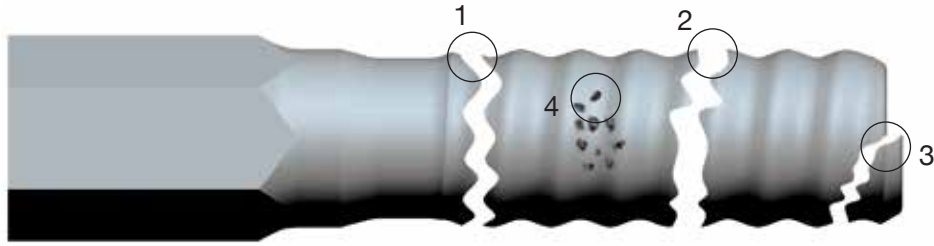

FAILURE	PROBABLE CAUSE	RECOMMENDED ACTION
POSITION - 1 Failure occurs where coupling ends or above the thread radius. Typically a sudden failure	i) Wandering or drifting hole	i) Employ straight hole drilling devices or systems
	ii) Worn threads and/or coupling. Migrating coupling (bridge worn out)	ii) Replace worn components. Do not put a worn coupling on a new rod. Change out your couplings with new rods
	iii) Bending due to overfeeding	iii) Monitor feed force and tune to rock conditions
	iv) Bending due to misalignment	iv) Utilize alignment tools to monitor hole orientation once the hole has been collared. Replace wear pads on feed
	v) Excessive rotation during rod retraction	v) Adjust drilling pressures
	vi) Heavy rotational loads caused by drilling with a dull bit and increased reflected stress	vi) Resharpen bits when the wear flats appear 1/3 dull or discard when carbide profile height is compromised
	vii) Drilling in voids, seams and/or broken conditions	vii) Adjust drilling pressures and tune to rock conditions
	viii) Continued percussion when drill steel jams in void or seam	viii) Use drill with anti-jam features. Reduce feed and percussion pressure
POSITION - 2 Fatigue through high surface tensile or shear stress, occurring 1/3 the way into the threads	i) Worn threads or surface galling	i) Replace worn components
	ii) Surface layer of thread damaged by a nick or dent caused by improper care and handling	ii) Store rods in a rod rack when retracting drill string. Do not drop rods
POSITION - 3 Chip broken off end of drill steel	i) Too much play in coupling. Drill steels improperly joined in coupling as a result of a thread or bridge wear	i) Replace worn components
	ii) Hammering end of steel on coupling	ii) Use a breakout plate to loosen joints
POSITION - 4 Galling in the threads and excessive heat (color change to blue)	i) Unused energy from percussive blow being reflected backwards to the drilling machine	i) Adjust drilling pressures and tune to rock conditions
	ii) Drilling with dull bits	ii) Resharpen bits when the wear flats appear 1/3 dull or discard when carbide profile height is compromised

CARE AND HANDLING

Bit Wear Overview	118
Bit Wear Patterns	119
Product Servicing	120
Recommendations	121

BIT WEAR OVERVIEW

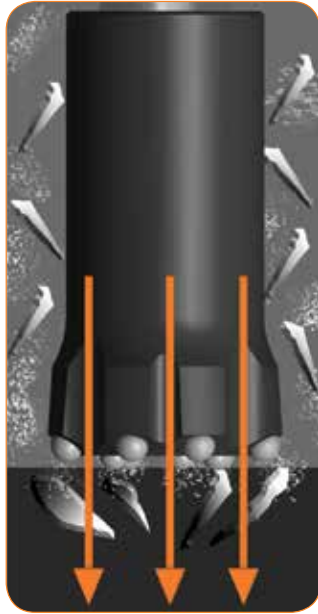

Sharp Bit

The percussive energy transferred into the rock is optimized, large rock chips are produced and the penetration rate is maximized.

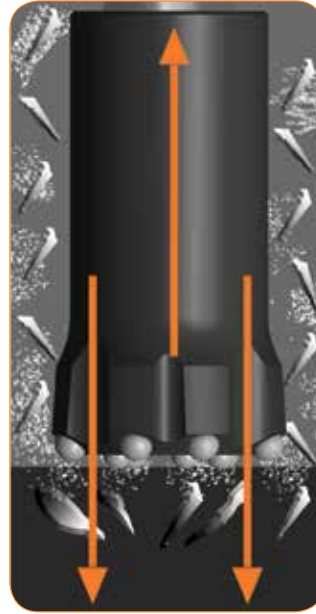

Flats Developing

The energy utilization is less effective after flats develop. Button penetration is decreased, more material is pulverized and smaller rock chips are produced. Less percussive energy is transferred into the rock and the unused energy is reflected back up the drill string, dissipating as heat and vibration. Bits should be sharpened before the wear flat widths reach 1/3 of the button diameter. Drilling with the wear flat wider than 1/3 of the button diameter increases the risk of shattering the carbide.



Excessive Wear

At this point button penetration is typically at its lowest. Much of the material in contact with the buttons is pulverized beneath the wear flats. The steel bit face is making contact with the hole bottom. Fewer and smaller rock chips are produced and much of the energy is reflected back up the drill string. This sacrifices the life of the drill string components and increases the wear and tear on your drill rig components. Additional crushing and pulverizing of the drill cuttings trapped between the bit matrix and the hole bottom occurs, further reducing penetration.

BIT WEAR PATTERNS



Gauge Wear

In some materials such as hard sand stone and quartzite, the wear tends to be greater on the bit circumference. Thus, when the buttons are sharpened, the diameter across the gauge buttons will be less than the diameter of the bit shoulders and the bit will tend to bind in the hole. Consider bit replacement.



Body Wash

When drilling in non-abrasive materials, where carbide wear is minimal, extended drilling intervals are possible. This allows for prolonged chip removal around the bits and will wear away the bit body to a greater extent than the buttons. Similar wear occurs in fractured and loose materials where excessive agitation and grinding of the materials is required for hole cleaning and to keep the hole open during retraction. To prevent tearing out buttons and button shear under these conditions, the protrusion should be reduced by scheduling grinding intervals to grind down the buttons.



Over Drilling

The detrimental effects of over drilling bits may not be immediately apparent. However, running dull bits not only slows down the drilling rates but escalates drilling costs by reducing life on the drilling tool components, the rock drills and the drill rig components. Premature button bit insert failures are reduced substantially when over drilling is eliminated and proper sharpening is performed.

PRODUCT SERVICING

Product Servicing - Button Bits

Large wear flats or the presence of snakeskin on the surfaces of buttons can lead to button failure. Similarly if the protrusion of the buttons above the level of the steel becomes reduced, penetration rates will drop and wear flats will develop rapidly. Under these conditions it is necessary to redress the bit to restore it, as near as possible, to its original geometry.

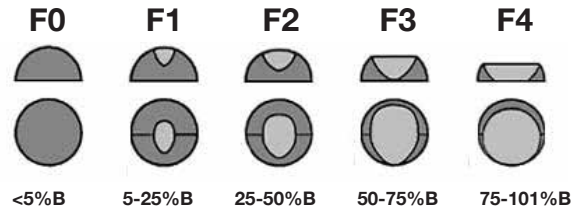

(Where B = Button Diameter)

Button Reshaping

If button protrusion is adequate, satisfactory reshaping can be achieved by use of a performed diamond faced tool. Sharpening is effected by holding the tool firmly against the button and orbiting the machine in a circle to achieve a uniform surface finish. Diamond faced tools are designed to cut carbide and not steel. It is therefore essential that ample protrusion of the button exists before the diamond tools are used.

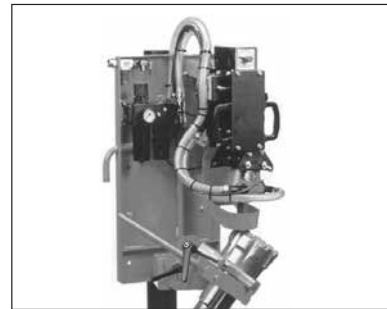

Product Servicing - Blade Bits

Tungsten carbide blade bits are precision tools, manufactured from high-quality material and engineered to provide the best results during the most difficult drilling conditions. Tungsten carbide is resistant to shock and wear, and for maximum results should be properly used and maintained. When sharpening bits, the idea is to restore them as closely as possible to their original 'tent' shape.

RECOMMENDATIONS

Inspect the Bit Frequently

Frequent inspection of a bit is necessary to prevent overdrilling. "A" indicates the worn edges of a used bit. Bits must be sharpened when the flat is wider than 1/8". When measuring the wear flat, take the measurement 1/4" from the outside of the bit. The point of greatest wear is usually the outside corners of the inserts. When this corner wear exceeds 3/16" the bit must be sharpened even though maximum flats may not have developed.

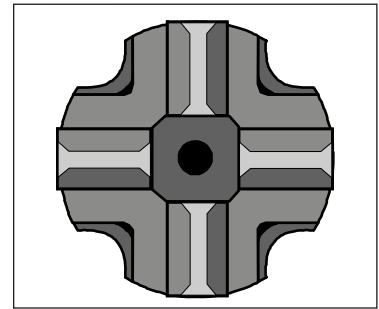

Gauge Grind Protruding Inserts

Drilling in abrasive rock will result in the steel wearing faster than the inserts. The protruding inserts, lacking sufficient steel support, can easily break while drilling and also when retracting the bit from the hole. To prevent this from occurring, gauge grind all protruding inserts flush with the steel body.

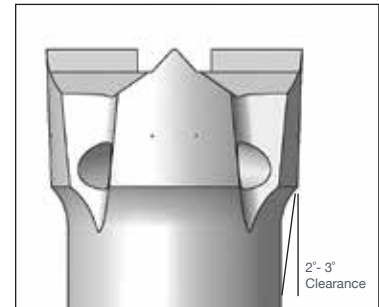

Blade Bit Sharpening

Silicon carbide grinding wheels are coded according to grit size, hardness, density, and bond variants. When sharpening blade bits, it is essential that the correct grade of wheel is used. If the wheel is too "hard", overheating of the carbide takes place causing cracking and rapid destruction of the insert. A soft wheel will wear out rapidly and produce a lot of grinding debris.



WARNING

NOTE: Use appropriate eye protection, masks and ventilation when grinding drilling bits. Grinding wheels and tungsten carbide inserts contain: Tungsten Carbide; Cobalt; Tantalum; Chromium; Nickel; Aluminum and Silicon. Grinding tungsten carbide inserts releases particles containing these elements that can irritate skin, eye, nose, throat and can result in lung damage.



WARRANTY

WARRANTY

Limited Warranty.

(a) Consumables. Boart Longyear warrants for a period of one (1) year after the date of shipment of the consumable products manufactured by it, or the performance of related services, under the Contract, that such consumable products are free from defects in materials and workmanship and such services are performed in a professional and workmanlike manner; provided, however, with respect to consumable products purchased through an authorized Boart Longyear distributor, the warranty period shall commence on the date of purchase by the end-user.

(b) Capital Equipment. Boart Longyear warrants that the capital equipment manufactured by it is free from defects in materials and workmanship for a period equal to the lesser of (i) one (1) year after the date of shipment, or (ii) the initial 1,000 operating hours. Boart Longyear warrants for a period of six (6) months after the performance of related services that such services are performed in a professional and workmanlike manner.

(c) General Terms. Boart Longyear further warrants that, to the extent applicable, as of the date of shipment or performance, all goods manufactured by it and services performed shall conform to the written specifications agreed between the parties. THIS IS BOART LONGYEAR'S ONLY WARRANTY. BOART LONGYEAR MAKES NO OTHER WARRANTY, INCLUDING WITHOUT LIMITATION, ANY WARRANTY OF MERCHANTABILITY OR FITNESS FOR A PARTICULAR PURPOSE. As a condition to Boart Longyear's warranty obligations, Purchaser must: (i) contact Boart Longyear and request authorization to return any goods claimed to be defective promptly upon Purchaser's discovery of the alleged defect, (ii) upon receipt of an approved authorization code from Boart Longyear, return any goods claimed to be defective under the foregoing warranty, at Purchaser's expense, to the facility designated by Boart Longyear, and (iii) with respect to consumable products purchased through an authorized Boart Longyear distributor, the party making the warranty

claim must also deliver to Boart Longyear reasonable evidence of the date of purchase. Boart Longyear shall perform its examination of the goods so returned by Purchaser and shall report the results of its examination to Purchaser within thirty (30) days following its receipt of such goods from Purchaser, or, if longer time is required to complete such examination, within such time as would be required through the exercise of reasonable diligence. As a further condition to Boart Longyear's obligations hereunder for breach of warranty, Purchaser shall offer its reasonable cooperation and assist Boart Longyear in the course of Boart Longyear's review of any warranty claim. If requested by Purchaser, Boart Longyear will promptly repair or replace, at Boart Longyear's expense, goods that are confirmed to be non-conforming as a result of Boart Longyear's examination and according to Boart Longyear's warranty as set forth herein. All removal and installation of goods shall be at Purchaser's expense; provided, however, Boart Longyear will reimburse the Customer for an amount equal to the reasonable expenses incurred by the Customer and attributable to the removal and shipment of any defective goods. Boart Longyear reserves the right to reimburse Purchaser for an amount equal to the purchase price of any defective goods in lieu of providing repaired or replacement goods. Anything contained herein to the contrary notwithstanding, in no event shall Boart Longyear be liable for breach of warranty or otherwise in any manner whatsoever for: (i) normal wear and tear; (ii) corrosion, abrasion or erosion; (iii) any goods, components, parts, software or services which, following delivery or performance by Boart Longyear, has been subjected to accident, abuse, misapplication, modification, improper repair, alteration, improper installation or maintenance, neglect, or excessive operating conditions; (iv) defects resulting from Purchaser's specifications or designs or those of its contractors or subcontractors other than Boart Longyear; (v) defects associated with consumable parts or materials, the lifetime of which is shorter than the warranty period set forth in this Section; (vi) defects associated with

WARRANTY

Purchaser's specifications or designs or those of its contractors or subcontractors other than Boart Longyear; (vii) defects resulting from the manufacture, distribution, promotion or sale of Purchaser's own products; or (viii) accessories of any kind used by the Purchaser which are not manufactured by or approved by Boart Longyear.

(d) Sourced Goods. If the defective parts or components are not manufactured by Boart Longyear, the guarantee of the manufacturer of those defective parts or components is accepted by the Purchaser and is the only guarantee given to the Purchaser in respect of the defective parts or components. Boart Longyear agrees to assign to the Purchaser on request made by the Purchaser the benefit of any warranty or entitlement to the defective parts or components that the manufacturer has granted to Boart Longyear under any contract or by implication or operation of law to the extent that the benefit of any warranty or entitlement is assignable.

(e) Limitation on Liability. Except as provided for herein, in no event will Boart Longyear be liable for any indirect, incidental, special, consequential, punitive or similar damages including, but not limited to, lost profits, loss of data or business interruption losses. In no event will the total, aggregate liability of Boart Longyear under the Contract exceed the value of the Contract under which liability is claimed. The liability limitations shall apply even if Boart Longyear has been notified of the possibility or likelihood of such damages occurring and regardless of the form of action, whether in contract, negligence, strict liability, tort, products liability or otherwise. The parties agree that these limits of liability shall survive and continue in full force and effect despite any termination or expiration of any Contract. Any action by Purchaser against Boart Longyear must be commenced within one year after the cause of action has accrued. No employee or agent of Boart Longyear is authorized to make any warranty other than that which is specifically set forth herein. The provisions in any specification, brochure or chart issued by Boart Longyear are descriptive only and are not warranties.



PRODUCT INDEX

PRODUCT INDEX

Part #	Page #	Part #	Page #	Part #	Page #	Part #	Page #
030003	27	090031	49	110566	43	110805	55
030032	27	090032	45	110576	37	110809	55
030037	27	090034	65	110577	48	110814	56
030039	27	090035	58	110580	34	110818	37
030099	24	090047	77	110591	43	110820	37
030110	27	110002	37	110597	42	110821	34
030113	27	110003	34	110599	78	110822	34
030115	27	110006	37	110600	32	110830	55
050022	22	110022	55	110609	42	110833	61
050036	26	110024	41	110611	37	110834	61
050066	26	110034	42	110612	76	110842	62
050068	26	110038	42	110615	43	110849	55
050069	22	110118	37	110621	48	110853	62
050081	26	110127	41	110634	56	110875	42
050096	26	110129	51	110646	42	110876	42
050109	26	110131	42	110653	32	110887	74
050111	26	110135	42	110654	48	110888	74
050114	23	110137	61	110656	55	110889	74
050118	23	110141	68	110657	43	110890	74
050122	24	110167	37	110661	61	110892	42
050130	24	110169	34	110662	67	110895	61
050141	24	110176	42	110663	67	110898	43
050145	24	110179	42	110664	43	110900	74
050146	24	110180	42	110674	55	110904	37
050172	23	110184	42	110675	78	110908	48
050175	24	110188	41	110676	78	110909	48
050177	26	110203	55	110677	78	110912	55
050181	26	110204	61	110678	78	110914	43
050220	24	110216	61	110679	78	110918	74
050222	23	110219	67	110681	78	110919	42
050225	27	110236	34	110682	78	110923	67
050226	24	110251	42	110684	34	110924	62
050228	26	110270	71	110690	34	110927	76
050234	26	110272	71	110691	34	110930	34
050241	26	110280	76	110699	67	110937	71
050242	26	110284	34	110701	67	110940	79
050244	26	110285	42	110703	67	110942	62
050254	26	110288	56	110708	42	110943	78
070009	35	110291	51	110712	55	110948	61
070009	37	110323	37	110713	61	110950	68
070009	45	110360	68	110716	62	110951	76
070011	35	110363	55	110718	55	110953	44
070011	37	110368	42	110719	55	110955	48
070011	45	110375	43	110720	55	110956	44
070020	35	110384	55	110722	61	110958	44
070020	37	110412	61	110723	61	110959	44
070020	45	110423	34	110724	62	110960	44
070021	28	110429	42	110725	62	110961	44
070022	28	110437	68	110726	67	110962	34
070028	46	110438	67	110727	71	110964	50
070028	49	110442	34	110730	43	110965	50
070030	46	110448	43	110737	68	110969	79
070030	49	110472	42	110738	48	110973	34
070032	46	110476	34	110739	48	110980	48
070032	49	110477	32	110741	56	110986	34
070034	46	110495	37	110748	43	110988	42
070034	49	110509	61	110749	34	110993	74
090008	45	110510	68	110754	42	110994	74
090018	48	110511	68	110765	42	110996	43
090019	58	110515	43	110766	61	110997	43
090021	58	110516	43	110770	43	120045	43
090023	65	110517	42	110772	42	120051	43
090024	58	110522	48	110775	37	120058	56
090025	65	110523	48	110777	42	120067	56
090026	58	110526	43	110778	43	120208	35
090027	65	110527	37	110790	61	120213	35
090028	58	110545	42	110793	55	120223	43
090029	45	110549	55	110799	43	120225	35
090030	45	110552	43	110800	43	120255	43

PRODUCT INDEX

Part #	Page #	Part #	Page #	Part #	Page #	Part #	Page #
120258	35	140163	64	200476	40	210160	33
120304	43	140169	64	200481	40	210164	73
120307	62	140174	77	200483	40	210175	53
120329	43	140176	64	200484	40	210177	59
120348	56	140178	64	200485	53	210180	73
120349	56	140187	72	200486	59	210185	51
130008	69	140189	72	200487	66	210187	51
130011	57	140190	52	200493	53	210188	51
130012	63	140191	52	200496	33	210189	54
130048	44	140193	52	200500	40	210190	54
130049	56	140195	77	200506	51	210191	54
130054	69	140196	44	200509	53	210192	54
130055	69	140197	44	200515	51	210193	60
130056	44	140202	77	200516	36	210194	60
130057	56	140203	63	200524	53	210195	60
130058	63	140205	52	200529	73	210196	66
130059	56	140208	44	200530	73	210197	66
130070	79	140212	69	200541	40	210198	73
130071	63	140217	79	200543	73	210199	73
130074	57	140218	64	203003	78	210200	33
130079	57	140221	64	203008	66	210201	54
130080	63	200034	40	203009	33	210202	50
130081	63	200087	51	203011	73	210203	78
130082	68	200102	33	210004	40	210204	78
130083	68	200106	33	210005	40	210205	60
130084	69	200169	40	210006	40	210208	33
130088	72	200171	29	210023	40	210209	33
130098	44	200190	29	210024	51	210213	59
130100	69	200259	40	210029	53	210214	73
130101	68	200316	53	210030	53	210216	78
130102	72	200320	59	210031	53	210218	66
130105	63	200357	40	210032	53	210219	73
130107	68	200361	59	210033	53	210220	78
130113	74	200362	59	210035	59	210221	73
130114	74	200363	66	210037	59	210222	66
130115	74	200364	66	210038	59	210226	60
130116	74	200365	53	210040	66	210227	66
130120	74	200366	53	210042	66	210230	54
130134	79	200367	53	210043	66	210231	54
130135	79	200372	40	210044	53	220024	36
130136	63	200375	53	210045	53	220038	38
130137	75	200376	33	210046	53	220042	39
140028	44	200377	51	210048	59	220068	36
140029	44	200378	33	210050	40	220075	36
140030	44	200379	59	210051	40	220095	38
140031	57	200383	53	210064	53	220096	38
140035	57	200386	59	210068	40	220100	38
140039	63	200397	59	210072	54	220112	38
140042	69	200398	66	210073	40	220115	38
140045	69	200401	40	210080	59	220138	33
140049	77	200404	66	210082	59	220144	38
140052	57	200411	51	210083	66	220152	38
140060	57	200416	53	210089	71	220157	38
140071	64	200417	53	210091	59	220159	38
140072	64	200418	59	210093	53	220161	38
140074	44	200422	66	210106	53	220164	39
140077	57	200424	78	210107	40	220166	39
140089	77	200426	78	210108	59	220170	39
140095	69	200427	59	210110	53	220179	33
140097	57	200428	78	210112	53	220194	36
140098	69	200431	78	210115	40	220198	36
140109	64	200438	59	210118	59	220202	33
140114	64	200447	53	210122	54	220209	39
140115	57	200455	59	210126	59	220219	33
140125	64	200456	40	210132	36	220229	33
140132	64	200463	59	210134	51	220242	36
140136	57	200464	59	210139	33	220257	38
140137	44	200468	59	210151	36	220262	33
140160	64	200474	33	210154	66	220265	36

PRODUCT INDEX

Part #	Page #	Part #	Page #	Part #	Page #	Part #	Page #
220271	38	250123	25	280007	54	380017	46
220275	47	250160	23	280009	54	380017	49
220277	38	250161	23	280032	54	380019	103
220286	33	250162	23	280033	60	400012	100
220287	33	250163	23	280034	41	400015	100
220292	39	250183	23	300010	39	400021	101
220296	36	250185	23	300012	39	400022	101
220303	33	250187	25	300022	39	400023	101
220306	47	250188	23	300036	39	400025	101
220309	33	250189	25	300039	39	450002	87
220365	47	250190	25	300042	47	450010	82
220384	39	250191	23	300050	47	450013	98
220399	38	250195	25	310001	25	450014	87
220400	38	250196	23	310003	25	450037	82
220404	33	250198	23	310005	25	450074	82
220414	38	250200	23	310007	25	450078	82
220415	38	250201	25	310009	25	450089	83
220420	33	250234	22	310010	23	450092	84
220426	47	250362	23	310012	25	450094	83
220431	32	250364	25	350002	58	450111	95
220441	33	250365	25	350005	35	450150	83
220443	33	250368	22	350010	29	450172	92
220444	33	250369	22	350011	46	450212	82
220449	36	250373	22	350012	65	450251	83
220453	47	250374	25	350013	70	450266	82
220455	47	250387	25	350014	70	450282	84
220464	39	250440	25	350029	52	450284	83
220471	38	250441	25	350033	37	450286	83
220476	47	250447	25	350034	65	450314	91
220477	47	250448	25	350041	52	450335	97
220480	47	250465	22	350045	58	450375	91
220483	38	250473	25	350046	65	450380	95
220484	38	250516	23	350048	70	450382	94
220494	39	250517	23	350050	46	450383	94
220497	39	250537	22	350051	79	450405	93
220498	33	250540	22	350052	79	450407	93
220500	39	250541	22	350054	35	450408	93
220501	39	250542	22	350057	75	450412	95
220502	39	250543	22	350059	49	450423	83
220503	39	250544	22	360008	100	450427	94
220506	47	250699	23	360014	100	450430	94
220507	39	250727	23	360017	100	450438	91
220508	39	250738	22	360018	100	450442	89
220510	39	260001	28	360029	100	450443	89
220513	38	260002	28	360030	100	450445	93
220514	47	260003	28	360031	100	450454	86
220515	47	260004	28	360035	100	450455	91
220523	39	260015	28	360039	100	450459	89
220781	47	260016	28	360045	100	450460	91
240020	27	260021	28	370008	100	450466	93
240022	27	270004	76	370009	100	450468	91
240035	28	270012	55	370014	100	450469	85
240037	28	270013	55	370015	100	450475	93
240038	28	270018	67	370022	100	450477	89
240045	27	270019	67	370031	100	450485	92
240046	27	270022	60	370035	100	450487	90
240050	28	270033	60	370037	100	450500	82
240095	27	270035	60	370038	100	450524	84
240096	28	270051	71	370045	100	450525	90
240137	27	270052	60	370047	100	450533	94
240145	27	270059	41	370049	100	450539	84
240160	27	270064	76	370050	100	450548	85
240164	27	270069	60	370051	100	450550	85
250063	25	270081	60	370052	100	450551	85
250118	25	270082	55	380003	37	450565	82
250119	25	270083	41	380003	45	450575	94
250120	25	270084	41	380007	46	450576	90
250121	25	270085	67	380007	49	450582	88
250122	25	270086	73	380015	35	450586	92

PRODUCT INDEX

Part #	Page #	Part #	Page #	Part #	Page #
450591	95	450872	97	07142438-11	29
450594	93	450873	96	07143237-11	29
450603	94	450878	85	07144036-11	29
450605	84	450879	97	07144835-11	29
450607	84	450889	84	07145634-11	29
450612	92	450890	89		
450613	92	450891	89		
450614	85	450895	86		
450629	86	450896	87		
450631	85	450899	87		
450632	84	450902	88		
450634	85	450909	86		
450636	94	450914	83		
450638	88	450916	85		
450640	88	560001	101		
450643	87	560014	101		
450644	87	560015	101		
450646	88	560016	101		
450652	82	560017	101		
450653	82	560019	102		
450667	86	560021	102		
450671	95	560023	102		
450700	94	560026	101		
450713	84	560036	102		
450743	90	560040	101		
450745	89	560052	102		
450747	97	560054	102		
450752	89	560063	102		
450753	92	560069	102		
450760	88	560078	102		
450761	89	560079	101		
450763	98	560080	101		
450771	89	560081	101		
450777	82	560082	101		
450778	82	560083	101		
450781	95	560085	101		
450783	95	560092	101		
450785	88	62022	102		
450793	90	62023	102		
450795	90	620004	102		
450801	90	620006	102		
450816	96	620007	102		
450818	88	620008	102		
450823	90	620013	103		
450824	88	620015	102		
450825	88	620016	102		
450826	85	630004	103		
450827	97	630006	103		
450835	95	630007	103		
450836	96	630008	103		
450839	93	630010	103		
450840	96	630013	103		
450841	96	660001	103		
450842	90	660003	103		
450846	96	690001	103		
450851	96	990058	72		
450852	96	990059	65		
450853	83	990060	72		
450854	83	990061	77		
450855	86	990063	72		
450856	84	990064	77		
450857	84	990067	52		
450858	85	3542857	104		
450861	88	5600005	104		
450862	92	07140641-11	29		
450863	85	07140840-11	29		
450868	94	07141240-11	29		
450870	94	07141639-11	29		
450871	93	07141839-11	29		



CONTACT INFORMATION

Global Headquarters

Boart Longyear
10808 South River Front Parkway, Suite 400
South Jordan, Utah 84095
United States of America
info@boartlongyear.com
Tel: +1 801 972 6430

Asia Pacific

Boart Longyear
26 Butler Boulevard
Adelaide, 5950
Australia
Tel: +61 8 8375 8375

Canada

Boart Longyear
2442 South Sheridan Way
Mississauga, Ontario
Canada L5J 2M7
Tel: +1 905 822-7922

Europe

Boart Longyear
12 Avenue des Morgines
CH1213 Petit-Lancy, Geneva
Switzerland
Tel: +41-22-709-0800

Latin America

Boart Longyear
Portal Riesco
Av. El Salto 4001, Huechuraba
Santiago, Chile 858 0641
Tel: +56 2 2595 33 00

